



**NONRESIDENT
TRAINING
COURSE**



July 1997

Electronics Technician

Volume 1—Safety

NAVEDTRA 14086

Although the words “he,” “him,” and “his” are used sparingly in this course to enhance communication, they are not intended to be gender driven or to affront or discriminate against anyone.

PREFACE

By enrolling in this self-study course, you have demonstrated a desire to improve yourself and the Navy. Remember, however, this self-study course is only one part of the total Navy training program. Practical experience, schools, selected reading, and your desire to succeed are also necessary to successfully round out a fully meaningful training program.

COURSE OVERVIEW: After completing this course, you should be able to: **Discuss** the primary causes of mishaps and methods for preventing mishaps; **Identify** the safety related responsibilities of the typical chain of command, from the commanding officer down to the individual worker; **State** the minimum information required to be listed on a hazardous materials label; **Explain** the general requirements and restrictions associated with purchasing, storing, handling, using, and disposing of hazardous materials; **State** specific requirements and restrictions associated with purchasing, storing, handling, using, and disposing of solvents, aerosol containers, PCBs, batteries, vacuum tubes, and cathode-ray tubes; **Explain** the effects of electric shock on the human body and **state** the methods of preventing electric shock; **Identify** the primary sources of hazardous electromagnetic radiation and effects on the human body; **State** the purpose of the tag-out bill and the personnel responsibilities, documents, and procedures associated with tag-out; and **Identify** and **state** the purpose of the primary safety equipment associated with Electronics Technicians.

THE COURSE: This self-study course is organized into subject matter areas, each containing learning objectives to help you determine what you should learn along with text and illustrations to help you understand the information. The subject matter reflects day-to-day requirements and experiences of personnel in the rating or skill area. It also reflects guidance provided by Enlisted Community Managers (ECMs) and other senior personnel, technical references, instructions, etc., and either the occupational or naval standards, which are listed in the *Manual of Navy Enlisted Manpower Personnel Classifications and Occupational Standards*, NAVPERS 18068.

THE QUESTIONS: The questions that appear in this course are designed to help you understand the material in the text.

VALUE: In completing this course, you will improve your military and professional knowledge. Importantly, it can also help you study for the Navy-wide advancement in rate examination. If you are studying and discover a reference in the text to another publication for further information, look it up.

*1997 Edition Prepared by
GSEC Steve Wheeler*

Published by
NAVAL EDUCATION AND TRAINING
PROFESSIONAL DEVELOPMENT
AND TECHNOLOGY CENTER

**NAVSUP Logistics Tracking Number
0504-LP-026-7520**

Sailor's Creed

“I am a United States Sailor.

I will support and defend the Constitution of the United States of America and I will obey the orders of those appointed over me.

I represent the fighting spirit of the Navy and those who have gone before me to defend freedom and democracy around the world.

I proudly serve my country's Navy combat team with honor, courage and commitment.

I am committed to excellence and the fair treatment of all.”

CONTENTS

CHAPTER	Page
1 . Naval Safety	1-1
2 . Hazardous Materials	2-1
3 . Electronics Safety	3-1
APPENDIX	
I . References Used to Develop The TRAMAN.	AI-1
INDEX	INDEX-1

NONRESIDENT TRAINING COURSE follows the index

SUMMARY OF THE ELECTRONICS TECHNICIAN TRAINING SERIES

This series of training manuals was developed to replace the *Electronics Technician 3 & 2 TRAMAN*.

The nine volumes in the series are based on major topic areas with which the ET2 should be familiar. Volume 1, *Safety*, provides an introduction to general safety as it relates to the ET rating. It also provides both general and specific information on electronic tag-out procedures, man-aloft procedures, hazardous materials (i.e., solvents, batteries, and vacuum tubes), and radiation hazards. Volume 2, *Administration*, discusses COSAL updates, 3-M documentation, supply paperwork, and other associated administrative topics. Volume 3, *Communication Systems*, provides a basic introduction to shipboard and shore-based communication systems. Systems covered include man-pat radios (i.e., PRC- 104, PSC-3) in the hf, vhf, uhf, SATCOM, and shf ranges. Also provided is an introduction to the Communications Link Interoperability System (CLIPS). Volume 4, *Radar Systems*, is a basic introduction to air search, surface search, ground controlled approach, and carrier controlled approach radar systems. Volume 5, *Navigation Systems*, is a basic introduction to navigation systems, such as OMEGA, SATNAV, TACAN, and man-pac systems. Volume 6, *Digital Data Systems*, is a basic introduction to digital data systems and includes discussions about SNAP II, laptop computers, and desktop computers. Volume 7, *Antennas and Wave Propagation*, is an introduction to wave propagation, as it pertains to Electronics Technicians, and shipboard and shore-based antennas. Volume 8, *Support Systems*, discusses system interfaces, troubleshooting, sub-systems, dry air, cooling, and power systems. Volume 9, *Electro-Optics*, is an introduction to night vision equipment, lasers, thermal imaging, and fiber optics.

INSTRUCTIONS FOR TAKING THE COURSE

ASSIGNMENTS

The text pages that you are to study are listed at the beginning of each assignment. Study these pages carefully before attempting to answer the questions. Pay close attention to tables and illustrations and read the learning objectives. The learning objectives state what you should be able to do after studying the material. Answering the questions correctly helps you accomplish the objectives.

SELECTING YOUR ANSWERS

Read each question carefully, then select the BEST answer. You may refer freely to the text. The answers must be the result of your own work and decisions. You are prohibited from referring to or copying the answers of others and from giving answers to anyone else taking the course.

SUBMITTING YOUR ASSIGNMENTS

To have your assignments graded, you must be enrolled in the course with the Nonresident Training Course Administration Branch at the Naval Education and Training Professional Development and Technology Center (NETPDTC). Following enrollment, there are two ways of having your assignments graded: (1) use the Internet to submit your assignments as you complete them, or (2) send all the assignments at one time by mail to NETPDTC.

Grading on the Internet: Advantages to Internet grading are:

- you may submit your answers as soon as you complete an assignment, and
- you get your results faster; usually by the next working day (approximately 24 hours).

In addition to receiving grade results for each assignment, you will receive course completion confirmation once you have completed all the

assignments. To submit your assignment answers via the Internet, go to:

<http://courses.cnet.navy.mil>

Grading by Mail: When you submit answer sheets by mail, send all of your assignments at one time. Do NOT submit individual answer sheets for grading. Mail all of your assignments in an envelope, which you either provide yourself or obtain from your nearest Educational Services Officer (ESO). Submit answer sheets to:

COMMANDING OFFICER
NETPDTC N331
6490 SAUFLEY FIELD ROAD
PENSACOLA FL 32559-5000

Answer Sheets: All courses include one “scannable” answer sheet for each assignment. These answer sheets are preprinted with your SSN, name, assignment number, and course number. Explanations for completing the answer sheets are on the answer sheet.

Do not use answer sheet reproductions: Use only the original answer sheets that we provide—reproductions will not work with our scanning equipment and cannot be processed.

Follow the instructions for marking your answers on the answer sheet. Be sure that blocks 1, 2, and 3 are filled in correctly. This information is necessary for your course to be properly processed and for you to receive credit for your work.

COMPLETION TIME

Courses must be completed within 12 months from the date of enrollment. This includes time required to resubmit failed assignments.

PASS/FAIL ASSIGNMENT PROCEDURES

If your overall course score is 3.2 or higher, you will pass the course and will not be required to resubmit assignments. Once your assignments have been graded you will receive course completion confirmation.

If you receive less than a 3.2 on any assignment and your overall course score is below 3.2, you will be given the opportunity to resubmit failed assignments. **You may resubmit failed assignments only once.** Internet students will receive notification when they have failed an assignment--they may then resubmit failed assignments on the web site. Internet students may view and print results for failed assignments from the web site. Students who submit by mail will receive a failing result letter and a new answer sheet for resubmission of each failed assignment.

COMPLETION CONFIRMATION

After successfully completing this course, you will receive a letter of completion.

ERRATA

Errata are used to correct minor errors or delete obsolete information in a course. Errata may also be used to provide instructions to the student. If a course has an errata, it will be included as the first page(s) after the front cover. Errata for all courses can be accessed and viewed/downloaded at:

<http://www.advancement.cnet.navy.mil>

STUDENT FEEDBACK QUESTIONS

We value your suggestions, questions, and criticisms on our courses. If you would like to communicate with us regarding this course, we encourage you, if possible, to use e-mail. If you write or fax, please use a copy of the Student Comment form that follows this page.

For subject matter questions:

E-mail: n315.products@cnet.navy.mil
Phone: Comm: (850) 452-1001, Ext. 1713
DSN: 922-1001, Ext. 1713
FAX: (850) 452-1370
(Do not fax answer sheets.)
Address: COMMANDING OFFICER
NETPDTC N315
6490 SAUFLEY FIELD ROAD
PENSACOLA FL 32509-5237

For enrollment, shipping, grading, or completion letter questions

E-mail: fleetservices@cnet.navy.mil
Phone: Toll Free: 877-264-8583
Comm: (850) 452-1511/1181/1859
DSN: 922-1511/1181/1859
FAX: (850) 452-1370
(Do not fax answer sheets.)
Address: COMMANDING OFFICER
NETPDTC N331
6490 SAUFLEY FIELD ROAD
PENSACOLA FL 32559-5000

NAVAL RESERVE RETIREMENT CREDIT

If you are a member of the Naval Reserve, you may earn retirement points for successfully completing this course, if authorized under current directives governing retirement of Naval Reserve personnel. For Naval Reserve retirement, this course is evaluated at 2 points. (Refer to *Administrative Procedures for Naval Reservists on Inactive Duty*, BUPERSINST 1001.39, for more information about retirement points.)

Student Comments

Course Title: Electronics Technician, Volume 1—Safety

NAVEDTRA: 14086 **Date:** _____

We need some information about you:

Rate/Rank and Name: _____ SSN: _____ Command/Unit _____

Street Address: _____ City: _____ State/FPO: _____ Zip _____

Your comments, suggestions, etc.:

<p>Privacy Act Statement: Under authority of Title 5, USC 301, information regarding your military status is requested in processing your comments and in preparing a reply. This information will not be divulged without written authorization to anyone other than those within DOD for official use in determining performance.</p>
--

NETPDTC 1550/41 (Rev 4-00)

NAVAL SAFETY

HISTORY OF NAVAL SAFETY

Safety awareness in the Navy can be traced back to 1818. The old saying “hindsight is 20/20” probably came from a gunner who, in 1817, lit a candle in the powder magazine. His action not only sent him and his crew into orbit, but also helped introduce the first naval safety regulation. That regulation dealt with fire and the handling of black powder aboard ships. Since then, experience has played the major role in developing the safety programs of today’s Navy. Here is a brief listing of some major milestones in the history of naval safety:

- 1917—Safety engineers were assigned to each major naval shipyard.
- 1922—Safety programs for civilian employees were introduced at all naval activities.
- 1929—Enlisted personnel on shore duty were included in safety programs.
- 1947—The Navy Department Safety Council was organized under the Director of Safety of the Office of Industrial Relations (OIR). Its original mission was to coordinate safety procedures and to provide communications between the bureau safety engineers and the technical staff of the OIR safety branch. In 1957, the council’s mission was expanded to include the development and maintenance of the U.S. *Navy Safety Precautions Manual*, OPNAV 34P1 (superseded by OPNAVINST 5100.23, *Navy Occupational Safety and Health [NAVOSH] Program Manual*).
- 1951—The transition from propeller to jet aircraft helped the Secretary of the Navy (SECNAV) to establish the Naval Aviation Safety Council. In 1955, the title was changed to Naval Aviation Safety Center.
- 1963—The Navy was shaken by the loss of the USS *THRESHER* (SSN-593), in which 129 sailors were lost. A court inquiry was convened to examine the circumstances leading to and surrounding the incident. The court’s findings

resulted in the creation of the Submarine Safety Program (SUBSAFE). Its purpose was to impose high standards of quality control on submarine construction and operations. In 1964, the Chief of Naval Operations (CNO) established the Submarine Safety Center at the Submarine Base in New London, Connecticut, to examine and coordinate all matters of submarine safety.

- 1966-1967—The SECNAV tasked CNO to review the entire Navy Safety Program after a series of fires, collisions, and other mishaps involving surface ships resulted in over 200 deaths and more than 100 million dollars in damage. On 3 May 1968, as a result of CNO’s findings, the SECNAV established the Naval Safety Center.
- 1970—The Occupational Safety and Health Act (OSHA) of 1970 became law. Insofar as possible, this law assures safe and healthful working conditions for every working person in the nation.
- 1971—The Naval Safety Center assumed the responsibility for the Navy’s Defensive Driver Education Program.
- 1972—The Navy implemented its Motorcycle Training Course.
- 1973—The Commander, Naval Safety Center, was designated as the CNO Safety Coordinator (OP-09F), reporting directly to the Vice Chief of Naval Operations. This designation made the Naval Safety Center’s mission more specific and all-encompassing.

Now refer to the *Navy Occupational Safety and Health (NAVOSH) Program Manual for Forces Afloat* (OPNAVINST 5100.19), chapter A2. Also read the *Standard Organization and Regulations of the U.S. Navy* (OPNAVINST 3120.32), chapter 7. The information in these chapters will enhance your knowledge of the NAVOSH program organization and

responsibilities and the naval safety program. When you have finished these reading assignments, return here and continue with this chapter.

OVERALL NAVY PROGRAM

The Assistant Secretary of the Navy (Installations and Environment): The assistant Secretary of the Navy (Installations and Environment) is the designated occupational safety and health (OSH) official for the Department of the Navy (DON) and establishes, maintains, and updates the occupational safety and health program that implements the requirements of the Department of Defense (DoD) OSH policy issuances to provide protection for both civilian employees and the military personnel.

Chief of Naval Operations (CNO): The CNO is responsible for implementation and management of the NAVOSH Program and, in coordination with the Commandant of the Marine Corps, for mutual concern:

- Provides appropriate NAVOSH policy and standards for all commanders.
- Establishes appropriate planning, programming, qualified staffing, and budgeting for the NAVOSH Program.
- Issues the requirements for records maintenance.
- Conducts research and development to preclude occupational hazards or exposures from causing physical injury or degrading health status or work performance.
- Develops a program of periodic formal inspections of workplaces.
- Provides for job-related medical support.
- Develops procedures for prompt investigation of reports of unsafe or unhealthy working conditions and ensures corrective action is taken within appropriate time periods.
- Ensures personnel receive thorough and continuing training on NAVOSH matters.
- Adopts, develops, and reviews proposed alternate standards and promulgates NAVOSH standards.

Fleet Commanders in Chief: Because safety is an inherent responsibility of command, all aspects of the Navy Occupational Safety and Health Program shall be implemented through the chain of command. Fleet

Commanders are responsible for ensuring that their commanders, commanding officers, and officer in charge:

- Conduct and maintain an aggressive and comprehensive NAVOSH program.
- Assign safety responsibilities to qualified personnel as a primary duty billet where feasible, otherwise as a collateral duty billet with appropriate training provided. Where possible, assigned safety officers should remain in these positions for at least 1 year.
- Develop a NAVOSH management evaluation mechanism for afloat commands that is to the extent feasible integrated with the command inspection program and conducted by the chain of command.

Type Commanders: Oversight of subordinate commands' NAVOSH Programs and coordination of matters of mutual concern are the primary responsibilities of Type Commanders. Accordingly, Type Commanders will:

- Ensure that subordinate afloat commands implement the NAVOSH Afloat Program.
- Conduct periodic NAVOSH inspections of group commands and conduct or assist in NAVOSH inspections of squadrons and afloat commands. Inspectors at a minimum, should complete the Afloat Safety Officer Course (A-4J-0020) at the Surface Warfare Officers School (SWOS) or the Submarine Safety Officer Course (F-4J-0020), as appropriate. Appropriately trained civilian safety specialists may assist in these inspections.
- Coordinate and promote those aspects of the NAVOSH Program of mutual concern to forces afloat.
- Coordinate industrial hygiene support.

Group Commanders will:

- Conduct or assist in the conduct of periodic NAVOSH inspections of subordinate commands. Afloat units with industrial hygiene officers (IHOs) assigned should be inspected by the next higher echelon command having a professional NAVOSH representative.
- Assist afloat commanders and squadrons to ensure that afloat workplace NAVOSH

discrepancies beyond shipboard capability are identified in the Workload Availability Package.

- Establish uniform guidance for small ships to implement NAVOSH Program management requirements, as appropriate.
- Ensure that the group safety officer attends the Afloat Safety Officer Course, as appropriate, prior to or within 6 months of assignment.

Squadron Commanders will:

- Conduct or assist in the conduct of periodic NAVOSH inspections of afloat commands. Afloat units with IHOs assigned should be inspected by the next higher echelon command having a professional NAVOSH representative.
- Provide or coordinate NAVOSH assistance for subordinate afloat commands.
- Appoint a collateral duty safety officer.
- Establish uniform guidance for small ships to implement NAVOSH Program management requirements, as appropriate.
- Ensure that the squadron safety officer attends the Afloat Safety Officer Course of Submarine Safety Officer Course, as appropriate, prior to or within 6 months of assignment.

Primary Program and Specified Support Areas:

The higher the echelon administration and management of the Occupational Safety and Health Program is divided into primary program areas and specified support areas.

The Commander, Naval Safety Center (COM-NAVSAFECEN): Monitors safety and occupational health statistics and provides direct support and assistance to fleet units in safety matters upon request.

MISHAP CAUSES

Although there are many definitions of a mishap, we chose this one as a starting point: A mishap is any *unplanned or unintentional event, no matter how serious, that stops or interrupts your work and results in personnel injury and/or property damage.*

There are three basic elements of a mishap:

1. A mishap is an unplanned or unintentional event.

2. A mishap stops or interrupts work.
3. A mishap involves contact that causes injury or property damage.

Here is an example that illustrates the three basic elements of a mishap:

You're trying to loosen a large nut with a wrench. The nut is rusted tight. As you apply extra pressure to the wrench, the wrench slips. You stagger backward and strike your head on a stanchion behind you.

In this example, there were three distinct unexpected happenings: (1) the wrench slipped; (2) you staggered backward; and (3) you hit your head on a stanchion behind you. The last happening fits the definition of a mishap. It was unexpected; it interrupted your work; and, as you would agree, you made contact that caused personnel injury or property damage.

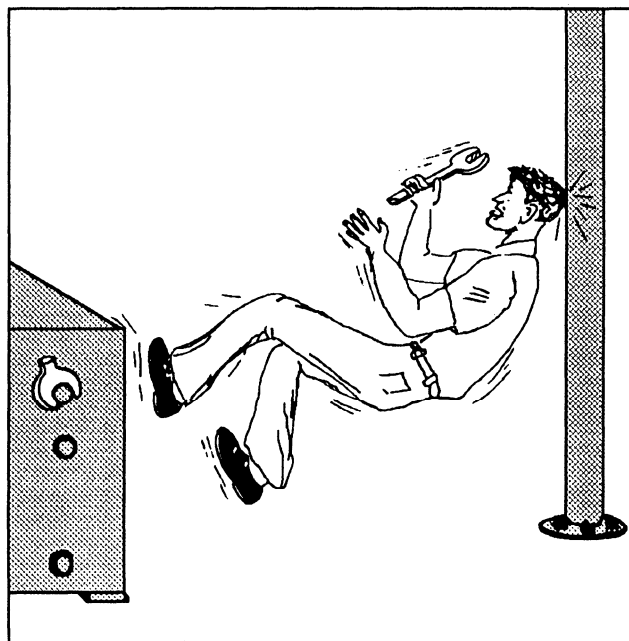

ETV10001

Mishaps are a pain! This is especially true when, after a mishap has occurred, you look back and say "If only I" and finish with a "had," "had not," or "did not." With that in mind, it's important for you to understand that you are both the number one cause and the number one cure for mishaps.

We know you want to do the best job you can. However, do you associate *safest* with *best*? If not, you'd better start right now!

Two facts that form the basis of mishap prevention are (1) mishaps are caused, and (2) the only way to stop them is to prevent or eliminate the causes. The more you know about the causes of mishaps, the better equipped you will be to prevent them.

A practical definition of a mishap cause is anything and everything that contributed to the mishap. The most common causes of mishaps are (1) you, and (2) your environment. They could include:

- Your unsafe actions or the unsafe actions of your coworkers
- An impaired physical or mental condition of the people who caused or influenced the unsafe actions
- Any defective or otherwise unsafe tools, equipment, machines, materials, buildings, compartments, or other aspects of the work environment

Studies reveal that the cause of at least two of every three Navy mishaps are caused by either a *worker's failure to do (or not to do)* something, or a *worker's taking short cuts* when performing a task. We call this "human error." See figure 1-1. In other words, **YOU** cause most of your own mishaps.

The following are some of the many factors that can lead you to mishaps:

- Inadequate training and lack of job experience
- Inadequate or outdated procedures in technical publications
- Inadequate posting or listing of the safety precautions you should observe when performing a task
- Behavioral factors, especially negative types of motivation
- Medically related factors that reduce your ability to work safely
- Communication problems caused by a breakdown in passing, receiving, or understanding information
- Poorly designed equipment, such as improperly placed controls

Refer to the following excerpt from *Electronics Installation and Maintenance Book (EIMB), General*, section 3, paragraph 3-1.1, for a brief discussion of the causes and effects of mishaps.

"Most accidents are preventable. However, through ignorance or misunderstanding, there is a common belief that they are the inevitable result of unchangeable circumstances or fate. This belief is untrue because it fails to consider the basic law of "cause and effect" to which accidents are subject. In other words, accidents do not occur without a cause; most accidents are the direct result of some deviation from prescribed safe operating procedures.

A preventable accident may be traced to causes as basic as the heredity and early environment of the individual. These causes may be revealed in the form of personal characteristics which permit the individual to perform an unsafe actor permit a hazardous condition to exist; when an accident results, the cause and effect sequence is completed.

One purpose of safety rules is to remind the individual of the dangers inherent in the work. Training in the observance of safety precautions can be instrumental in avoiding preventable accidents and in maintaining a work environment which is conducive to accident-free operation. Operating procedures and work methods adopted with hazard prevention as a specific criteria do not expose personnel unnecessarily to injury or occupational health hazards. Accidents which are about to happen can be prevented if the "cause" is detected and appropriate remedial action is taken."

INADEQUATE TRAINING AND EXPERIENCE

Many mishaps occur because of inadequate training and lack of job experience. You may find yourself assigned a task that is clearly beyond your skill level. This may be because of an operational requirement or an emergency that requires prompt action. Or, your supervisor may not be aware of your limitations.

These situations may cause you to misread instructions, take short cuts, or make other errors that could result in a mishap. Also, your chances of a mishap increase when you are not aware of the hazards associated with a particular task. It's this lack of awareness that can keep you from taking the necessary precautions.

In simple English—(1) **DON'T TAKE SHORT CUTS**, and (2) **ASK FOR HELP**. If you think a task is too hazardous, it probably is. And before you attempt to do it, seek guidance and become familiar with its associated hazards.

Estimated Frequency of Mishaps Involving Personnel Error

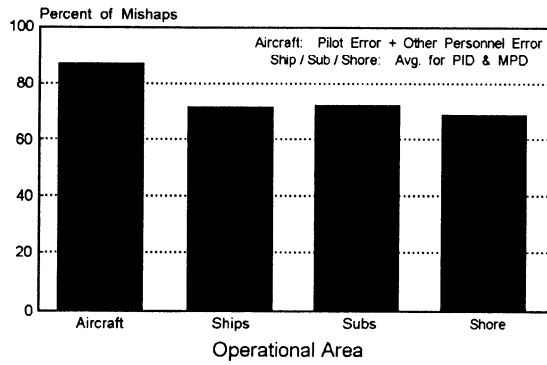

Jan 86 - 31 Dec 90

Distribution of Responsibility for Material Property Damage

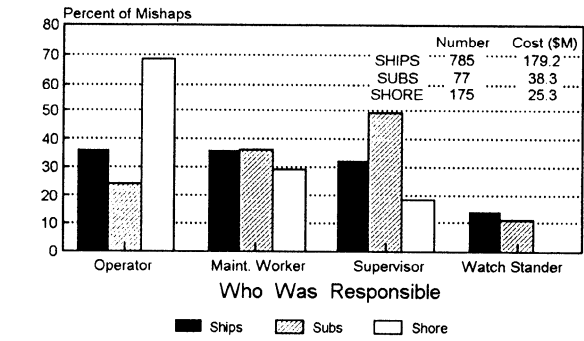

1 Jan 86 - 31 Dec 90

Distribution of Responsibility for Personal Injuries/Death

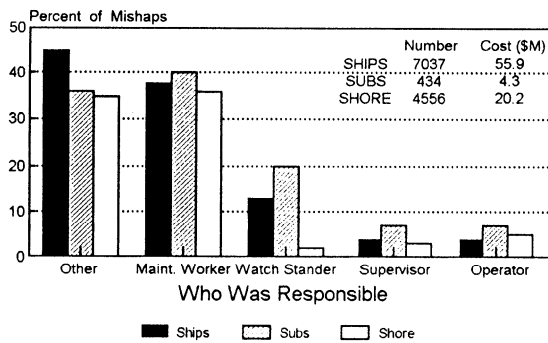

1 Jan 86 - 31 Dec 90

What Responsible Person Failed to Do that Caused Material Property Damage

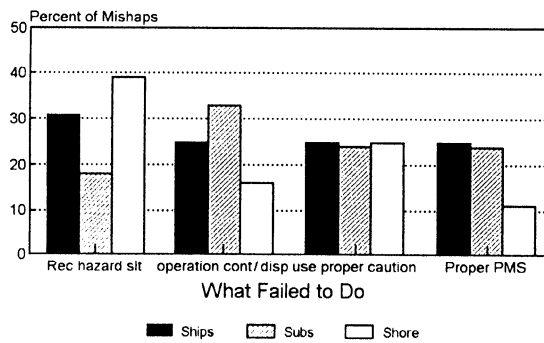

1 Jan 86 - 31 Dec 90

What Responsible Person Failed to Do that Caused Personnel Injuries/Death

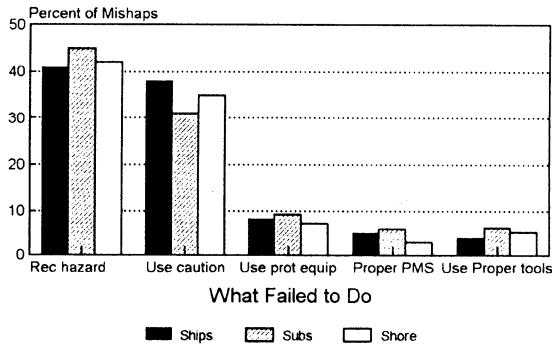

1 Jan 88 - 31 Dec 90

ETV10002

Figure 1-1.—Mishap causes.

INADEQUATE OR OUTDATED PROCEDURES

When a mishap occurs, examine the procedures you followed just before the mishap. They may be in error or they may not provide enough detailed “how-to” information. Or, perhaps the technical manual was not updated when a piece of equipment was upgraded or replaced. As a result, you could inadvertently be using the wrong procedures for a particular task. If this is the case, *take the initiative* to complete the required paperwork to update the technical manual.

INADEQUATE SAFETY PRECAUTIONS

You **must** be aware of the safety precautions associated with the job or task you are performing. They must either be posted in your work area or listed in the technical manual you’re using. If they aren’t available, you could be attempting something hazardous and not even know it. Make sure you read ALL applicable precautions. Even if you performed the task before and are familiar with it, it’s possible that new or revised precautions exist.

BEHAVIORAL FACTORS THAT CAUSE MISHAPS

Your behavior is much more complex than the equipment you operate and maintain. Equipment, regardless of how it’s designed and powered, is predictable in its response to certain cues or signals. If a piece of equipment quits working, you can isolate the fault to a specific part with the use of test equipment and schematics. This isn’t true for you. Your behavior while performing a task is based on a combination of factors that come from your

- unique experiences,
- knowledge,
- attitude, and
- motivation.

Each of the above factors can affect your behavior regarding safety. Behavior that leads to a mishap is usually caused by undesirable *attitudes* and *motivations*.

• **Attitudes.** Attitudes are complex mental states that affect your reaction toward some object, event, or state of affairs. They cause you to form opinions and act in certain predictable ways, some favorable and others

unfavorable. Attitudes that do not support safe behavior hamper mishap prevention. And, they can also actually cause mishaps.

• **Motivations.** Motivations are incentives for specific acts. Your behavior is based on your motivation, and your motivation is shaped by your attitudes. Ensuring that you have positive motivations toward job safety is clearly a very complex problem. It’s complicated because you do not simply react to the basic needs of comfort, security, affiliation, and self-fulfillment. Your motivations on and off the job are also greatly affected by the attitudes, feeling, tensions, and emotions of the world around you. The following are some undesirable motivations that can lead you to mishaps in the workplace:

- Motivation to save time and effort
- Motivation to maintain personal comfort
- Motivation to gain approval and attract attention
- Motivation to express resentment

Motivation to Save Time and Effort

You may sometimes be more concerned about doing a job quickly than you are about doing it safely. You may believe that saving time and effort will leave extra time for “shooting the breeze” or taking a break. Or, you may just find satisfaction in being the first to finish.

Motivations like these can cause incorrectly disassembled parts, jury-rigged equipment, incorrect use of tools, improper procedures, equipment damage, and injury. Sometimes a command’s operational commitments or a supervisor’s demands, if excessive, will lead to unsafe actions that you normally wouldn’t consider doing.

Motivation to Maintain Personal Comfort

Sometimes you perform a job incorrectly because some of the actions required to perform the job properly cause you discomfort. For example, when a task calls for safety goggles, you may decide not to wear them because they’re uncomfortable. The same can apply to hearing protection, safety shoes, and safety harnesses. You may believe you aren’t susceptible to injury—but you are.

Motivation to Gain Approval and Attract Attention

Even though you're normally cautious, you may use hazardous practices if you find the people around you use and approve of such practices. Some of your coworkers may do this because of a need for recognition and status. This is especially true if they are the type who receive more criticism than praise because their normal work habits are poor and hazardous. Such people may seek recognition by driving recklessly, drinking excessively, ignoring standard operating procedures, acting impulsively, disobeying orders, and showing off. While these actions may satisfy their immediate need for recognition, they also threaten mishap prevention efforts, and maybe your life.

Motivation to Express Resentment

Many mishaps occur because of immature, irresponsible, or insubordinate behavior. This happens if you or a coworker becomes angry or resentful, and try to strike out at or get even with someone, such as your supervisor.

MEDICAL FACTORS THAT CAUSE MISHAPS

Medical factors such as illness, physical impairment, alcohol abuse, fatigue, and motion sickness, can cause mishaps. These factors are frequently associated with either a high tempo of operations that prevents proper rest and nourishment or with events carried over from a recent return from leave or liberty.

Illness

Your ability to work safely is sometimes affected by illness or the side effects of medicine. Temporary illness like colds, flu, dizziness, heat stress, and nausea can weaken your physical abilities.

They can either reduce your strength, stamina, and coordination, or disrupt your concentration, mental alertness, memory, and reasoning ability. These side effects of medication, such as drowsiness, sluggishness, and lack of coordination, can sometimes lead to mishaps.

Physical Impairments

Any pre-existing physical impairment, such as a lower back injury, a slipped disc, or a hernia, may make

you more susceptible to mishaps. Mishaps can also stem from visual and hearing defects. Common visual problems include color blindness, faulty depth perception, farsightedness, and nearsightedness. Hearing defects cause mishaps if they prevent you from hearing instructions or a warning signal.

Alcohol Abuse

Some people think alcohol is a stimulant. Nothing is farther from the truth. Alcohol is a chemical depressant. It acts as a general anesthetic for the parts of the brain that suppress, control, and inhibit thoughts, feelings, and actions. Alcohol typically impairs your judgment, gives you unrealistic confidence, slows your coordination, and degrades your performance. These effects are present whether you feel them or not. It's these effects that cause the risk-taking type of behavior that can lead you to unsafe acts that cause mishaps.

Fatigue

Fatigue is not an all-or-nothing factor. It begins when you start a task, and it increases as you continue to perform the task. At some point during the task, fatigue can become great enough to impair your performance. It can decrease your work output, change your attitude, and reduce your motivation to observe safety precautions. But long before this happens, fatigue will decrease your awareness and reflex actions. It's at this point where mishaps can occur. The following are some symptoms of fatigue:

- Lower quality of performance
- Irritability
- Impatience
- Forgetfulness
- Confusion
- Higher number of errors

The following are some frequent causes of fatigue:

- Hard work, long hours, and lack of sleep.
- Environmental stress, such as heat, cold, noise, inadequate lighting, and vibration.
- Boredom and monotony.
- Change in routine. Suppose, for example, you're accustomed to working days and sleeping nights. If you switch to working nights and

sleeping days, you will probably experience fatigue.

The results of fatigue vary from person to person, but fatigue always reduces your mental alertness, increasing the chances of a mishap occurring.

Motion Sickness

Anything that hinders your normal alert behavior can cause a mishap. Motion sickness can weaken, distract, disorient, and cause you severe nausea. In the early stages of motion sickness, you may experience a decrease in responsiveness and mental alertness. These symptoms may increase carelessness, which can lead to a mishap. Your reduced mental alertness will degrade your decision-making abilities. This, in turn, can increase your chances of having a mishap. As motion sickness progresses, you may be drowsy and have cold sweats and nausea.

COMMUNICATION PROBLEMS THAT CAUSE MISHAPS

Mishaps can occur when there is a breakdown in the passing, receiving, or understanding of information. The most common communication problem is misunderstanding the message being sent to you. Your brain reacts to what *it thinks* it hears, not necessarily *what* it hears. Mishaps can also stem from language barriers. You can't understand a message if the person sending the message doesn't speak clearly enough.

EQUIPMENT DESIGN FACTORS THAT CAUSE MISHAPS

Poorly designed equipment and improperly placed controls can cause mishaps. Controls that can't be reached quickly and easily, emergency controls protected by cumbersome interlocks, and displays that are difficult to read are examples of design problems that can cause mishaps. Now, refer to the *Navy Occupational Safety and Health (NAVOSH) Program Manual for Forces Afloat*, OPNAVINST 5100.19, and read chapter A6.

Also read enclosure (4) *Afloat Safety Program* (OPNAVINST 5100.21). The information contained in these publications will enhance your knowledge of the overall Mishap Prevention Program.

MISHAP PREVENTION

Why is mishap prevention necessary? Because the product of the Navy is national defense, the quality of your performance must be far superior to that of any potential adversary. The Navy's business is deadly serious. It's conducted by professionals, restricted to limited resources, and allows **no** room for waste. Mishaps produce waste. Therefore, when mishaps are reduced, waste is reduced, and readiness is improved.

The Navy also considers **your** safety to be as important as productivity. Unlike most civilian businesses whose safety efforts are directed at reducing on-the-job mishaps, Navy mishap prevention efforts give you complete coverage, both on and off the job, regardless of your duty status, location, or mission.

Mishap prevention is a vital part of your job. By preventing mishaps, you avoid injury to yourself and damage to your equipment. When you think of mishaps, you probably think of deaths. But in 1991, aboard ships and submarines and ashore, for every death, there were 111 mishaps that resulted in equipment damage or personal injury.

Mishap prevention is the process of eliminating mishap-producing causes. The goal of the Navy's mishap prevention program is to prevent mishaps from occurring or, once they have occurred, to prevent them from recurring. The Navy's mishap prevention program consists of activities directed to eliminate (1) unsafe acts of persons, and (2) unsafe mechanical, physical, or chemical working conditions.

The best way to prevent mishaps is to eliminate the factors that lead to mishaps. This can involve anything from a minute of extra effort by you that costs nothing to lengthy planning and work by many people at considerable cost. It all depends on the nature of the unsafe condition.

The authority to correct an unsafe condition may involve any level of the chain of command. The following four avenues are available to you.

1. **Order correction where authority permits.** If you have the authority to do so, don't delay ordering unsafe conditions corrected. Delay means exposure of other people to the unsafe condition. If you're uncertain about the best correction method, talk to your supervisor immediately.

2. **Report conditions to higher authority.** If you don't have the authority to correct the unsafe conditions, then promptly report the hazardous or

potentially hazardous conditions to your supervisor. Be ready to offer some suggestions about how to correct the unsafe condition. Your ideas may help to speed the correction.

3. Correct the problem at the source. Don't stop with just correcting the unsafe condition. Find its source and begin your corrective actions there. If you have the authority to correct the problem at the source, then do so. If the problem involves people, then point out the unsafe condition and correct the workers causing it. Hold on-the-spot training if needed. If you don't, you're inviting repetition of the unsafe practice.

4. Take temporary precautions. You may need to delay correcting an unsafe condition because of a shortage of funds, personnel, or equipment. If this happens, take whatever temporary precautions you need to protect both yourself and your coworkers from the unsafe condition until it can be corrected. These precautions may include

- securing the hazardous areas,
- disconnecting power sources,
- posting warning signs, and
- giving verbal warning to workers.

Whatever precautions are necessary, take them promptly to reduce the exposure of any hazardous condition to all personnel.

Here is an important final word about your responsibility to correct unsafe conditions. Sometimes an unsafe condition may arise that needs **IMMEDIATE** corrective action. This is especially true in situations that pose an immediate hazard to life or health. Don't delay because you may not have the authority to correct such an unsafe condition. In emergencies, **YOU HAVE IT!** Just be sure you don't put yourself or others in danger of being hurt. And, if you can't **SAFELY** correct the problem, inform your supervisor about it immediately.

SAFETY RESPONSIBILITIES

From the commanding officer on down the chain of command to each individual, safety is everyone's business. Even though the safety program is ultimately the responsibility of the commanding officer, everyone must take part in the program for it to be successful. The following paragraphs briefly describe the specific responsibilities of the key individuals in a command's safety program.

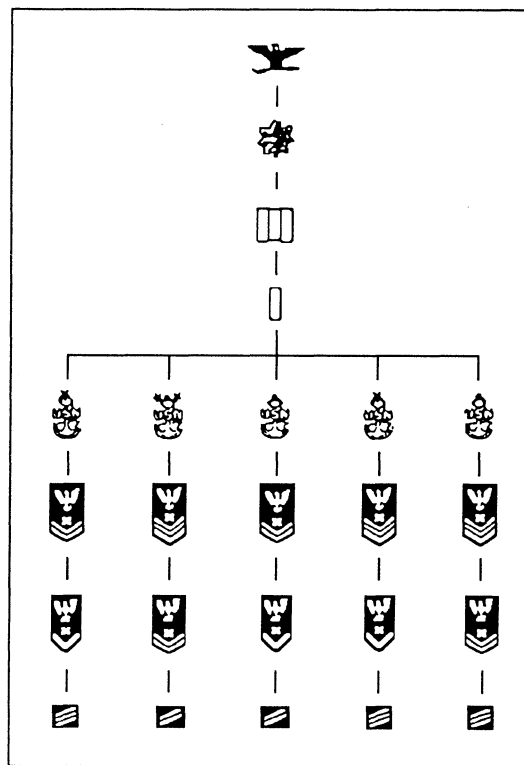

COMMANDING OFFICER

Commanding officers are directly responsible for the safety of all personnel under their command. They cannot delegate this responsibility. However, they can give all officers and petty officers under their command enough authority to make sure everyone understands and follows all prescribed safety precautions.

COMMAND SAFETY OFFICER

The command safety officer is responsible to the commanding officer for coordinating a complete safety program based on the objectives established by the commanding officer. Specifically, he or she performs the following safety related functions:

- Acts as principal advisor to the commanding officer on all internal safety matters
- Coordinates the commandwide safety program
- Promotes maximum cooperation for safety matters at all levels
- Ensures widest dissemination of all safety information

- Monitors submission of required safety and mishap reports to ensure accuracy and timeliness
- Maintains appropriate safety records and mishap statistics
- Serves as a member of the command's safety council and senior member of the enlisted safety committee
- Serves as the safety council recorder on aircraft carriers

DEPARTMENT SAFETY OFFICER

Safety officers for each department support their department head's responsibilities in all safety matters. In doing this, each department safety officer performs the following functions:

- Keeps the department head informed of the status of the safety program within the department
- Performs mishap prevention functions as assigned by the department head
- Acts as the department's point of contact in coordinating and evaluating the ship's safety program
- Ensures that all hazardous conditions revealed through hazard reports are corrected
- Maintains a record of mishap and hazard reports
- Maintains direct liaison with the ship's safety officer

DIVISION SAFETY OFFICER

The safety officer for each division is the division officer. On some small ships where the division officer is the department head, the division safety officer may be a senior enlisted member. In performing his or her duties, the division safety officer

- Keeps the department safety officer advised of the status of the safety program within the division
- Acts as the division's point-of-contact in coordinating and evaluating the ship's safety program

- Designates a senior petty officer, E-5 or above, as the division safety petty officer
- Investigates the division's mishaps and near-mishaps
- Makes sure that corrective action is taken on hazardous situations revealed by mishap and hazard reports and on recommendations made in mishap reports
- Ensures that all division personnel receive mishap prevention training

DIVISION SAFETY PETTY OFFICER

The division safety petty officer reports directly to the division safety officer in all safety matters. In performing his or her duties, the division safety petty officer should

- Become thoroughly familiar with all safety directives and precautions concerning the division
- Conduct the division's mishap prevention training and maintain the related records
- Assist in mishap investigations as directed
- Make recommendations regarding the safety program to the division safety officer
- Assist the division safety officer in performing division safety duties
- Act as technical adviser on mishap prevention within the division
- Serve on the command safety committee

MAA/SAFETY FORCE

MAA/Safety force personnel shall:

- Be roving inspectors for hazards that could result in injury to personnel or damage to equipment. All roving security patrols will have this additional duty.
- Assist the Safety Officer in keeping the Safety Program visible to all personnel.
- Carry out a system of internal reporting to focus command attention on material deficiencies and operating practices that jeopardize personnel and equipment.

PERSONAL SAFETY RESPONSIBILITIES

So far, we've discussed the responsibilities of key personnel within your command's safety program. You may now be asking yourself "Where do I fit into the picture?" Remember, **safety is everyone's business**. Here are your specific responsibilities for safety— follow them wherever you are and no matter what you are doing:

1. Observe all the safety precautions related to your work or duty. You may have gotten by with being careless with safety rules in the past, but your luck will not hold out forever. If you continually cross a street without looking, eventually you'll get hit by a car.

2. Report any unsafe conditions or any equipment or material you think might be unsafe. Don't just walk by an open manhole or turn in a broken tool without saying anything about it. **Report it!** Remember, if you think it's unsafe, then it probably is.

3. Warn others of hazards that exist. If you see someone knowingly, or unknowingly, place himself or herself or others in danger, say something. If necessary, report the situation to your supervisor.

4. Report any injury or ill health to your supervisor. A splinter in your finger or a scratch on your leg, if treated immediately, will usually not cause any more trouble. But if left untreated, it may become infected, and what would normally be a 10-minute trip to sick call, may turn into a 10-day hospital stay.

5. Wear protective clothing whenever appropriate or required. If you're issued electrical safety shoes, wear them. It's cheaper and easier to replace a \$50 pair of shoes than it is to treat your injuries.

6. Be safety conscious. Always remain alert to dangers that may exist.

7. Always inspect equipment and associated attachments for damage before you use them. Make sure the equipment you are using is suited for the job. Check the safety precautions that pertain to each piece of equipment.

Remember, SAFETY should be your first thought before you begin a task and throughout the task, throughout the day.

REMEMBER

I AM YOUR WORST ENEMY

I am more powerful than the combined armies of the world. I have destroyed more men than all the wars of all the nations. I massacre thousands of people every year. I am more deadly than bullets, and I have wrecked more homes than the deadliest guns.

In the United States alone, I steal over 150 million dollars each year. I spare no one, and I find my victims among the rich and the poor alike, the young and the old, the strong and the weak. Widows and widowers know me to their everlasting sorrow. I loom up in such proportions that I cast my shadow over every field of labor.

I lurk in unseen places and do most of my work silently. You are warned against me, yet you heed me not. I am relentless, merciless, and cruel. I am everywhere: in the home, on the streets, in the factory, at the railroad crossing, on the land, in the air, and on the sea.

I bring sickness, degradation, and death, yet few seek me out to destroy me. I crush, I maim, I devastate—I will give you nothing and rob you of all you have.

I am your worst enemy——**I AM CARELESSNESS.**

HAZARDOUS MATERIALS

What are hazardous materials? They are substances which, depending on their concentration, chemical or physical characteristics, or quantity, pose a threat to human health or the environment. Any flammable material, compressed gas, aerosol, toxic material or corrosive is a hazardous material. Cleaning solvents, paints, batteries, and floor wax are all examples of hazardous materials. To do our job, and maintain equipment and areas, we must use hazardous materials. Whether we use hazardous materials daily or infrequently, we need to know how to identify them and to understand their use, storage, and disposal.

RECOGNIZING HAZARDOUS MATERIALS

All hazardous materials and hazardous material containers must be labeled. Manufacturers of hazardous materials must follow strict OSHA regulations on labeling. Each label must contain, at least:

1. The name of the material
2. The name and address of the manufacturer
3. The nature of the hazard

Hazardous materials we receive from the stock system, and even open purchase materials, must meet these requirements. You are not authorized to relabel properly labeled hazardous materials. If you dispense a hazardous material into an unlabeled container, you **must** indicate on the new container the same label information shown on the original container.

The Department of Defense (DOD) has a standard label for marking hazardous materials dispensed or produced by DOD agencies. You may also use this label to mark unlabeled containers. The label is called the Hazardous Chemical Warning Label, DD Form 2522, and is shown in figure 2-1. The information for this label is printed directly from the Hazardous Material Information System (HMIS) computer database.

You may also see Department of Transportation (DOT) shipping symbols on the outside of some hazardous material containers. These symbols, shown in figure 2-2 depict the hazard category of the material.

These symbols are used on outer packaging, and are also found on trucks and railway cars transporting those materials.

Types of materials that are either **Dangerous**, **Flammable** or **Combustible** are indicated by a diamond with applicable nomenclature that is red in color. Materials that are **Explosive** by nature are indicated by a diamond with applicable nomenclature and red coloring.





Types of materials that are either **oxidizing agents**, **organic peroxide**, or **radioactive** are indicated by a diamond with applicable nomenclature with yellow coloring. Materials that are either **poisonous gas**, **poison**, or **corrosive** are indicated by a diamond with applicable nomenclature and all black and white coloring. Non-flammable gases are indicated by a diamond with applicable nomenclature and green coloring. **Flammable solid** materials are indicated by a diamond with applicable nomenclature and red, blue, and white coloring.

You **must** read the labels on the hazardous materials you use. The label may also contain some handling precautions or other warnings that help you use the product safely.

HAZARDOUS MATERIAL INFORMATION

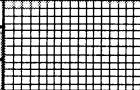
Many hazardous materials, if not used properly, can be hazardous to your health. They can burn or irritate your skin, cause internal damage if you inhale them, or poison you if you ingest them. You must be aware of and follow safe handling, storage, and disposal procedures for the hazardous materials you work with.

OSHA regulations require employers to provide every employee with safety information on the hazardous materials they deal with at work. This law also pertains to federal civilian and military personnel. Manufacturers must provide hazardous material information for all hazardous materials they produce and must make a Material Safety Data Sheet (MSDS) available to the user for each hazardous material. In the Navy, MSDSs are provided in a computer database on compact disk-read only memory (CD-ROM) system

HAZARDOUS CHEMICAL WARNING LABEL					
1. CHEMICAL/COMMON NAME					
2. HAZARD CODE			3. NSN/LSN		
4. PART NUMBER					
5. ITEM NAME					
6. HAZARDS (x all that apply)	(1) Acute (Immediate)				(2) Chronic (Delayed)
	NONE	SLIGHT	MODERATE	SEVERE	
a. HEALTH 					
b. CONTACT 					
c. FIRE 					
d. REACTIVITY 					
7. SPECIFIC HAZARDS AND PRECAUTIONS (Including Target Organ Effects)					
(See MSDS for further information)					
8. PROTECT (X all that apply)		a.EYES		b.SKIN	c. RESPIRATORY
9. CONTACT: a. COMPANY NAME					
b. ADDRESS (Street, P.O. Box, City, State, Zip Code and Country)					
c. EMERGENCY TELEPHONE NUMBER (Include Area Code)					
10. PROCUREMENT YEAR FOR HAZARDOUS CHEMICAL					

DD Form 2522 (1C), DEC 88

S/N 0102-LF-012-1100
☆GPO: 1991-507-027

ETV10004

Figure 2-1.—Department of Defense Hazardous Chemical Warning Label, DD Form 2522 (1C).

called Hazardous Material Control and Management (HMC&M). This database contains several publications and a system called the Hazardous Material Information System (HMIS). The HMIS provides over 70,000 MSDSs for materials used within the Department of Defense.

The MSDS must be available to any user of hazardous material. CD-ROM systems with the HMC&M are provided on board every ship and shore station. The MSDS is used to train hazardous material

users on the hazards and precautions of that material. MSDSs contain:

1. General information, including an emergency phone number
2. Ingredients and identity information
3. Physical/chemical characteristics
4. Fire and explosion hazard data
5. Health and hazard data, including first aid

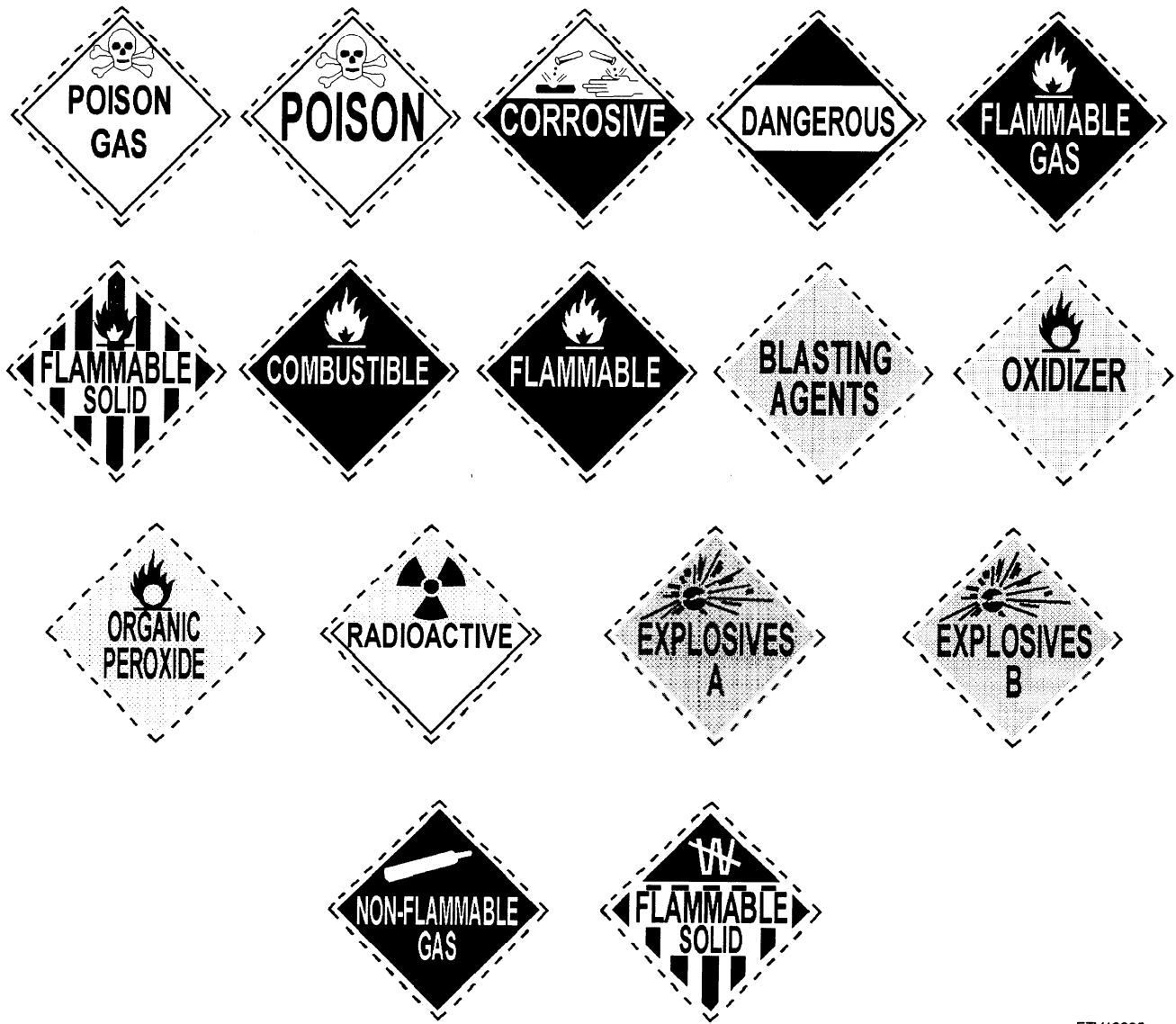

ETV10005

Figure 2-2.—Department of Transportation hazardous material shipping symbols.

6. Precautions for safe handling and use
7. Control measures, including protective equipment
8. Transportation data
9. Disposal data
10. Label data

Your Hazardous Material Control Program Manager, Hazardous Material/Hazardous Waste Coordinator, or Safety Officer can provide you with MSDSs upon request. Ashore, the MSDSs for a work center will be located within that work area. Aboard ship, the MSDSs are available through your supervisor.

Safety information on hazardous materials is also available in chapter C23 of *Navy Occupational Safety and Health (NAVOSH) Program Manual for Forces Afloat*, OPNAVINST 5100.19.

SAFETY PRECAUTIONS FOR HAZARDOUS MATERIALS

You **must** follow the prescribed safety precautions for the hazardous materials you use or handle in your workplace. There are requirements for personal protective equipment, spill response, and disposal of waste that you need to know. This section will cover safety precautions for the following types of materials

commonly used or handled by Electronics Technicians: *solvents, aerosol containers, polychlorinated biphenyls, batteries, and vacuum tubes.*

SOLVENTS

Varnishes, lacquers, cleaning fluids, and some paints contain solvents that can ignite at relatively low temperatures. Such materials pose a serious fire hazard. Some solvents give off toxic vapors that are harmful if you inhale them. Some will also cause serious problems if they come in contact with your skin.

Many solvents are used in the day-to-day maintenance of electronic equipment. The safest solvents are those that dissolve in water (water-based). If water-based solvents won't work, the two most popular non-water-based solvents are *trichloroethane* and *methyl alcohol*. Both of these are **EXTREMELY** flammable. Use these only when you have adequate ventilation.

When you use hazardous paints or solvents, always follow these safety precautions:

- 1 . If you spill them, **wipe them up immediately.**
- 2 . Place rags or other items you use to clean them up **in a separate, covered container.**
- 3 . **Use** protective clothing, goggles, gloves, or other appropriate **safeguards** to prevent the paints or solvents from getting on your skin or in your eyes.
- 4 . Have **accessible fire-fighting equipment nearby.**
- 5 . Have **adequate ventilation.**
- 6 . **Dispose** of the paints and solvents when you no longer need them. Make sure you dispose of them properly. If you are unsure of the disposal procedures, check with the safety officer.
- 7 . Store flammable solvents in approved flammable storage lockers. Make sure you store flammable and corrosive materials separately.
- 8 . **Do Not** use carbon tetrachloride. This is a highly toxic compound and is banned from use. Use trichloroethane instead.
- 9 . **Do Not** smoke or use an open flame or allow anyone else to do so in areas where paint, varnishes, lacquers, or solvents are being used.

10. **Do Not** breathe the vapors of any cleaning solvent for prolonged periods. If you don't have proper ventilation, use a respirator.
11. **Do Not** spray cleaning solvents on electrical windings or insulation.
12. **Do Not** apply cleaning solvents to heated equipment, since this could cause a fire.

AEROSOL CONTAINERS

Aerosol containers are everywhere. You use them to groom your hair, to clean and freshen your living quarters, and to paint parts of the equipment you work on. When properly used, aerosol containers will dispense their chemicals quickly and effectively. But if they're misused, they can hurt you and cause damage to your surroundings. To prevent this, you must be aware of the dangers of aerosol containers and how to protect yourself from them.

Before using any aerosol container, read the label on the container. It usually has instructions on how to use, store, and dispose of the container safely. **Do Not** ignore these instructions. If you do, you may become sick from the toxic effects of the chemicals in the container. Or, even worse, you may be seriously injured if the container explodes.

Here are some basic rules to follow when using aerosol containers:

- 1 . Make sure you **have plenty of ventilation** when you use aerosols that contain dangerous or toxic gases. If you must use such aerosols when ventilation is not adequate, wear the appropriate respiratory equipment.
- 2 . Dispose of the containers **according to the instructions of your supervisor.** Some aerosol containers are considered hazardous waste.
- 3 . **Keep** all aerosol **containers away from** open flames, sunlight, heaters, and other possible sources of **heat.**
- 4 . **Do Not** spray paint or other protective coatings on warm or energized equipment. You may cause a fire.
- 5 . **Do Not** spray any paints or solvents on your skin. Some liquids in aerosol containers may burn you, while others may cause a skin rash.
- 6 . **Do Not** dent or puncture these containers. They are pressurized and can explode if dented or punctured.

- 7 **Do Not** store these containers in heated areas where temperatures can exceed the recommended storage temperature on their labels. Aboard ship, all aerosols are considered flammables and must be stored in a flammable liquid storage compartment or cabinet.
- 8 **Do Not** discard these containers in wastebaskets that will be emptied into an incinerator; they could explode.

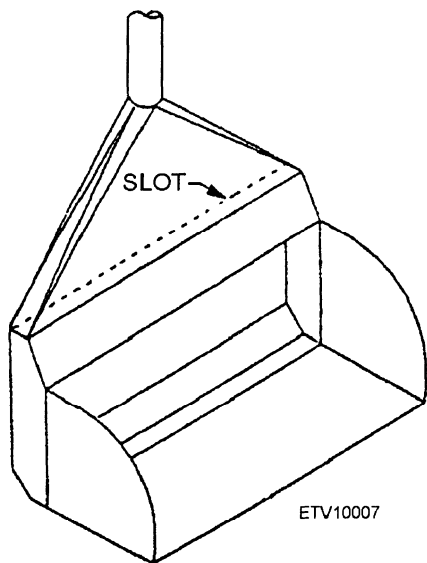

POLYCHLORINATED BIPHENYLS (PCBs)

Polychlorinated biphenyls (PCBs) are toxic chemicals belonging to the chlorinated hydrocarbon group of substances. They range in form and appearance from oily liquids to crystalline solids and hard transparent resins. These chemicals exhibit many favorable physical and chemical properties, including high heat capacity, chemical stability, noncorrosivity to metals, low flammability, low vapor pressure, and low electrical conductivity. They have, therefore, been used extensively as insulators and coolants in electrical equipment.

Any PCBs in use aboard ship will typically function as insulating fluids or coolants within electrical equipment. (The chemicals might occasionally be found in totally-enclosed hydraulic and heat transfer systems.)

Remember, these chemicals are **toxic**. That means they can be harmful to your health or even deadly. Their adverse effects can result from either brief or repeated exposure. The effects from short-term contact with high

concentrations of PCB vapors or liquids include eye, nose, and throat irritation, headaches, and a skin rash known as chloracne. Repeated exposure can result in severe skin irritation, respiratory irritation, digestive tract damage, and damage to the liver. Systemic intoxication, that is, an adverse effect to your entire bodily system, can result from severe overexposure. Systemic intoxication is indicated by nausea, vomiting, weight loss, jaundice, and abdominal pain, and can be fatal.

To protect all personnel, all equipment and cabinets containing in-service small and large PCB capacitors should be marked with the label shown in figure 2-3.

You can find additional information on PCBs in the *Shipboard Management Guide for Polychlorinated Biphenyls (PCBs)*, NAVSEA S9593-A1-MAN-010. Although we do not require that you read this publication, we highly recommend that you do so.

BATTERIES

A battery consists of a group of cells that provide a source of direct-current electrical power. Batteries are used in automobiles, boats, aircraft, ships, submarines, lighting equipment, and portable and stationary electrical and electronic equipment. They can be used as main power sources or as secondary or backup power sources. Some batteries are rechargeable and some are not.

Batteries can be dangerous. If used or handled improperly, they can explode, release toxic gases, or leak hazardous chemicals. This section gives you the

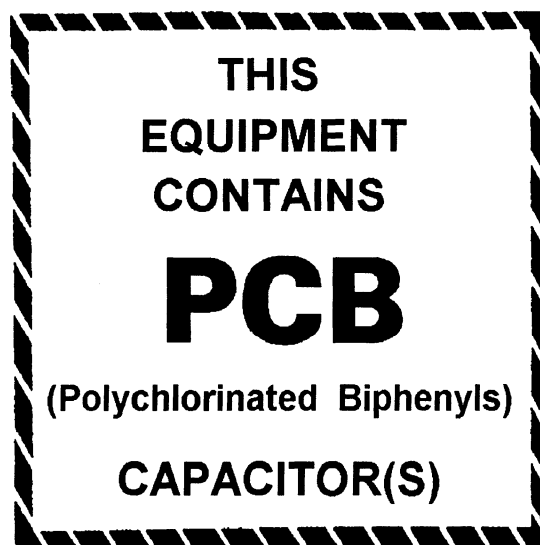

Figure 2-3.—Sample 4" x4" EPA-required label.

safety precautions for the following six types of batteries ETs are most likely to see:

1. Carbon-zinc
2. Manganese-dioxide alkaline-zinc
3. Mercuric-oxide
4. Lithium
5. Lead-acid
6. Nickel-cadmium

Carbon-Zinc Dry Cell Battery

This is a very common battery in the Navy. It has a zinc outer container, a carbon center electrode, and a chemical paste for the electrolyte. It is usually sealed in a cardboard or plastic casing.

There are three important safety precautions concerning using, storing, or disposing of carbon-zinc batteries:

1. **Do Not** store carbon-zinc batteries in electronic equipment for extended periods. The corrosive electrolyte could leak out of the battery and damage the equipment.
2. **Do Not** throw carbon-zinc batteries into a fire; they could explode. Keep them away from incinerators.
3. **Do Not** throw carbon-zinc batteries overboard while at sea. These batteries contain metal pollutants. Store them on board (in a steel container) until you can properly dispose of them ashore.

Manganese-Dioxide Alkaline-Zinc Cell Battery

Commonly called an *alkaline* battery, this type of battery is similar to the carbon-zinc battery. The only difference is the type of electrolyte used. You'll find these batteries in portable electronic equipment. The safety precautions for alkaline batteries are identical to the safety precautions for carbon-zinc batteries.

Mercuric-Oxide Zinc Cell Batteries

Commonly called *mercury cells*, these batteries are small and powerful. They have longer shelf life than the two previous types of batteries. They were first used to power miniature equipments of the space program. Today these batteries are used in electronic test

equipment, cameras, hearing aids, periscope cameras, missiles, cryptographic equipment, and sonar devices.

Mercury cells are safe when used properly. But, if they're misused, **BOOM!**, they could explode. Use the following safety precautions for mercury batteries:

1. **Do Not** place a direct "short circuit" on a mercury cell.
2. **Do Not** discharge a mercury cell after its voltage falls below 70 percent of its original voltage, or after it fails to operate the equipment it is in.
3. **Do Not** leave the battery switch on when the equipment isn't in use, or after the mercury cell fails to operate the equipment.
4. **Do Not** expose mercury cells to temperatures over 400 degrees Fahrenheit.
5. **Do Not** keep exhausted mercury cells. Discard them as soon as possible. If you're at sea, store them temporarily under water in a steel container until you can dispose of them properly ashore. When you store exhausted mercury cells, never purposely puncture their jackets.

Lithium Cell Batteries

Lithium batteries are high-energy, long-lasting batteries with a longer shelf life than most other batteries. They are making their way into electronic equipments. They're used in computers, communications and cryptographic equipments, torpedoes, and missiles. Unfortunately, lithium batteries can be very dangerous. They've been known to release toxic gases or to explode. If you handle lithium batteries, observe the following safety precautions to prevent injury to yourself and damage to your equipment:

1. Use **only** lithium batteries that are approved for use in your equipment.
2. Store them in **cool, well-ventilated areas** away from flammable items.
3. **Always observe polarity** when you install them.
4. **Do Not** pierce, short-circuit, recharge, crush, cut, burn, drop, dismantle, modify, or otherwise carelessly handle them.
5. **Do Not** leave them in equipment that won't be used for long periods.
6. **Do Not** throw them away with daily trash. Dispose of them properly. See the

Environmental and Natural Resources Program Manual, (OPNAVINST 5090.1), for more disposal information on lithium batteries.

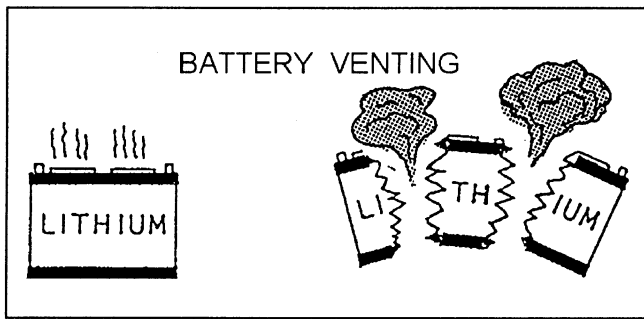

ETV10008

If you use lithium batteries on a daily basis, we recommend that you get a copy of the *Technical Manual for Batteries, Navy Lithium Safety Program Responsibilities and Procedures*, NAVSEA S9310-AQ-SAF-010, and read through it.

Lead-Acid Cell Batteries

This is the most widely used wet-cell battery. It is also one of the most dangerous batteries to use and maintain. Lead-acid batteries use sulfuric acid, and their battery gases (mainly hydrogen) are extremely explosive. You'll see this battery in automobiles and large backup power systems.

Remember, lead-acid batteries are very dangerous. To prevent injury to yourself, you should use the following safety precautions:

1. **Always** keep open flames and sparks of all kinds away from lead-acid batteries.
2. Be **sure** to have proper ventilation when you charge lead-acid batteries to prevent the build-up of hydrogen gas.
3. Follow the manufacturer's instructions when charging lead-acid batteries.
4. Handle battery acid (electrolyte) **VERY** carefully. This material is highly corrosive to the skin and eyes and requires full body protection.
5. Keep the battery acid **above** the tops of the separators.
6. Use **only** pure, distilled water when adding liquid to lead-acid batteries.

7. **Do Not** operate lead-acid batteries in temperatures over 125 degrees Fahrenheit (52 degrees Celsius).
8. **Do Not** connect or disconnect charging connections when charging current is flowing.
9. **Do Not** short-circuit lead-acid battery terminals.
10. **Do Not** pour water into battery acid; always pour the acid into the water. And, make sure you wear appropriate skin and eye protection whenever you handle battery acid.
11. **Do Not** put or allow salt water into a lead-acid battery. It will create an extremely toxic chlorine gas.

Nickel-Cadmium Cell Batteries

Commonly known as **NICADs**, nickel-cadmium batteries are used in most cordless, rechargeable equipment, such as flashlights, cordless drills, and soldering irons, and in portable stereos.

The following safety precautions for NICADs are relatively simple:

1. Charge NICADs in series, **never** in parallel.
2. **Always** follow the manufacturer's instructions for charging NICADs.
3. **Do Not** expose NICADs to temperatures over 113 degrees Fahrenheit (45 degrees Celsius).
4. **Do Not** short-circuit NICADs.
5. **Do Not** store NICADs and lead-acid batteries in the same container or in the same area.
6. **Do Not** dispose of NICADs by throwing them overboard. Temporarily store exhausted cells in a steel container until you can dispose of them properly ashore.

VACUUM TUBES

There are basically two categories of vacuum tubes: (1) *electron tubes*, and (2) *cathode-ray tubes*. There are certain safety precautions you need to follow when working with or handling vacuum tubes. The following paragraphs provide a brief discussion on the safety precautions for each category of tube.

Electron Tubes

Electron tubes are fairly rugged devices. Most of them can handle the shocks and knocks of everyday use. However, they are **not** indestructible. Most electron tubes contain a near vacuum enclosed by glass. Any excessive stress, like dropping the tube, may cause the glass to shatter, causing an **IMPLOSION**. An implosion is the opposite of an explosion. When the glass shatters, the outside air rushes into the tube to fill the vacuum. As the air rushes into the tube, it carries the glass fragments with it, right on through the center of the tube and out the other side. If you're in the path of these flying fragments, you could be seriously injured. So, handle **ALL** electron tubes with care.

Some electron tubes contain radioactive material. These must be handled with **EXTRA** care. Radioactive material is added to some electron tubes to aid ionization. Unbroken, the radioactive tubes are as safe as other electron tubes. This is because the tube's radioactive material emits slow-moving particles that are contained within the tube's thick glass envelope. But breaking the tube will expose the hazardous radioactive material.

To prevent injury to yourself or others, use the following safety precautions when handling either regular or radioactive tubes:

1. Handle **ALL** electron tubes, whether radioactive or not, with **EXTREME** care.
2. Immediately put any electron tube that has just been removed, whether radioactive or not, into a protective container, such as its shipping container.
3. Let your supervisor know immediately if a radioactive electron tube is broken.
4. **Seal off a radioactive-contaminated area immediately** so no other personnel are exposed to the radioactive material.
5. Treat **all** bad or damaged radioactive electron tubes as radioactive waste and dispose of them accordingly.
6. **Do Not** remove a radioactive tube from its shipping container until you're ready to install it.
7. **Do Not** let your skin come in contact with **any** radioactive fragments. If it does, wash yourself thoroughly with soap and water and get medical attention.

Cathode-Ray Tubes

Cathode-ray tubes (CRTs) are everywhere. They're used in televisions, desktop computers, radars, and electronic warfare systems. You'll probably maintain electronic systems that use CRTs. So, it's important for you to know about their hazards, and how to handle and dispose of them.

• **CRT hazards:** CRTs can be extremely hazardous. A CRT consists of a large glass envelope that maintains a high vacuum inside. It also has a toxic phosphor coating on its face. CRTs are under great atmospheric pressure. For example, a 10-inch CRT is subject to nearly 2,000 pounds of force. Of that, 1,000 pounds is felt on the tube's face alone. Therefore, if you break the glass envelope, it will cause a violent implosion.

When a CRT breaks, high external pressure causes it to implode (burst inward). As a result, all the glass fragments, metal parts, and toxic phosphor are expelled violently.

A CRT can also be hazardous when it's energized. This is because it carries a **very high voltage** and **emits X-rays**.

• **CRT handling:** To protect yourself from serious injury, you must never do anything that would cause the CRT's glass envelope to break and cause an implosion. When handling CRTs, follow these precautions:

1. Always follow the manufacturer's handling instructions.
2. Keep a new CRT in its shipping carton until you're ready to use it.
3. When you remove a defective CRT, place it in a shipping carton **immediately**.
4. Wear gloves and goggles.
5. **Do Not** remove a CRT until the high-voltage anode has been discharged.
6. **Do Not** strike or scratch the surface of a CRT's glass envelope.
7. **Do Not** stand in front of a CRT when you install it. If the CRT should implode, the electron gun in its neck could be propelled at a very high velocity through the face of the tube and into your body.
8. **Do Not** carry a CRT by its neck.
9. **Do Not** come in contact with phosphor coating; it is extremely toxic. If a CRT should break,

clean up the glass fragments very carefully. And, if you touch the phosphor, go to medical.

- **CRT disposal:** CRTs are disposed of by shipping them back to the manufacturer, or by discarding them locally. If you ship a CRT back to the manufacturer, put it in the shipping container intact. If you dispose of it locally, follow the procedure that has been prescribed by your safety officer.

HAZARD REPORTING

The reporting of unsafe or unhealthful conditions in the work place is extremely important. Each identified/validated hazard shall be assigned a Risk Assessment Code (RAC) by the activity safety office. The RAC represents the degree of risk associated with the deficiency. Hazard severity categories shall be assigned by Roman numeral according to the following criteria.

1. **Category I—Catastrophic:** The hazard may cause death, or loss of a facility.
2. **Category II—Critical:** May cause severe injury, severe occupational illness, or major property damage.
3. **Category III—Marginal:** May cause minor injury, minor occupational illness, or minor property damage.
4. **Category IV—Negligible:** Probably would not affect personnel safety or health, but is nevertheless in violation of a NAVOSH standard.

Mishap Probability is the term used to describe the probability that a hazard will result in a mishap, based on an assessment of such factors as location, exposure in terms of cycles or hours of operation, and affected population. Mishap probability shall be assigned an Arabic letter according to the following criteria:

1. Subcategory A—Likely to occur immediately or within a short period of time.
2. Subcategory B—Probably will occur in time.
3. Subcategory C—May occur in time.
4. Subcategory D—Unlikely to occur.

GENERAL STOWAGE REQUIREMENTS

Proper stowage of hazardous material is essential to ship and personnel safety. The supply department and individual work center personnel are responsible for proper stowage of hazardous material in areas under their cognizance. For answers to your questions concerning hazardous material stowage, consult your supervisor, supply officer, or your hazardous material/hazardous waste coordinator.

Hazardous materials aboard ship are typically packaged in cases or allotments of individual containers.

Do not store hazardous materials in heat producing areas, or near heat-producing items. Shield hazardous material stored on the weather deck or in exposed areas from direct sunlight.

Temporary stowage of hazardous material in work spaces should be limited to the quantity necessary for one work shift.

We recommend that you get a copy of *Naval Ships' Technical Manual*, Chapter 670, "Stowage, Handling, and Disposal of General Use Consumables," and read sections 3 through 6 to enhance your knowledge on stowage of the material covered in this chapter. Additional information is also provided in chapter C23, of the *NAVOSH Program Manual for Forces Afloat*, (OPNAVINST 5100.19).

CHAPTER 3

ELECTRONICS SAFETY

ELECTRIC SHOCK

Ninety-nine percent of what you do, you'll do around electricity. This makes you extremely susceptible to electric shock. It's very important for you to know these four things about electric shock:

1. What it is.
2. What factors affect how severe it can be.
3. How to avoid it.
4. What to do if you see someone being shocked.

DEFINITION OF ELECTRIC SHOCK

Electric shock is the *sensation and muscular spasm caused when electric **current** passes through the body.* Note that the word *current* is bold in the last sentence. This is to emphasize that it is *current* and NOT the *voltage* that causes electric shock. No matter how much voltage is present, you'll only get shocked if you provide a ground-path for the electric current.

Here is an example taken from a mishap report:

While trying to align the RF turret assembly of a high frequency transmitter, a Third Class Electronics Technician (ET3) received a shock from 1,000 volts of direct current (dc).

While doing preventive maintenance, the technician discovered the high frequency (HF) transmitter did not meet the performance specifications required by the Maintenance Requirements Card (MRC) of the Planned Maintenance System (PMS). After trying to tune the transmitter using the front panel meter, the technician determined the turret assembly was faulty.

The ET3 removed a high voltage insulation cover to get into the transmitter turret assembly adjustment fitting. While adjusting the turret, his thumb brushed a power amplifier tube plate connection. The 1,000 volts dc at the plate

connection entered the ET3's thumb and forearm before finding its way to ground.

The ET3 went to medical and the corpsman sent him to the naval hospital for evaluation and observation. The technician was released the next day.

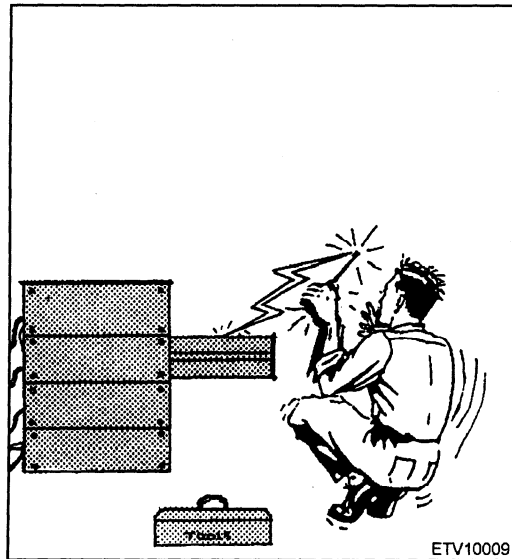

SEVERITY OF ELECTRIC SHOCK

The following factors determine the severity of the effect electric shock has on your body:

- The amount of current that is flowing through your body.
- The path the current takes through your body.
- The amount of body resistance you have to the current flow.
- The length of time the current flows through your body.

Path of Current Flow

The two most dangerous paths that current can take through your body are from (1) hand to hand, or (2) from

your left hand to either foot. The second path is the MOST dangerous path since the current will flow through both your heart and your vital organs.

Amount of Body Resistance

Your body resistance varies greatly in different parts of your body. A value of 1500 ohms is commonly used as the resistance between major extremities of an average human body: hand to hand, or hand to foot. Let's use Ohm's Law to figure how much current would flow through your body if you accidentally grabbed a wire carrying 120 volts alternating current (vac).

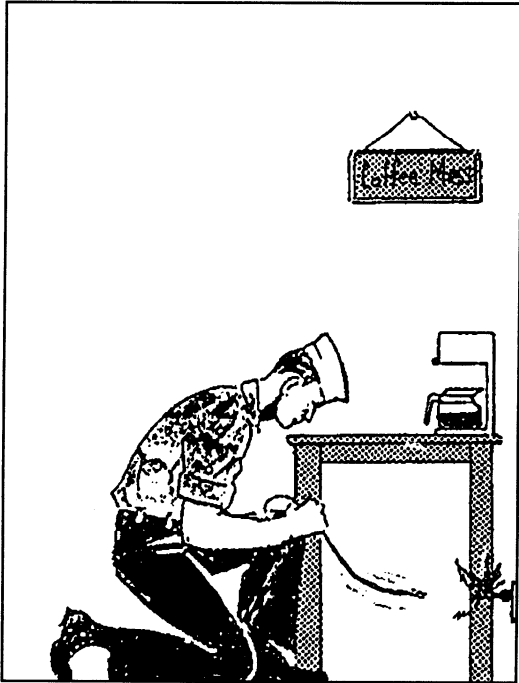

ETV10010

Ohm's Law for figuring current is $I = E/R$.

Let $E = 120 \text{ VAC}$ —The voltage you grabbed

Let $R = 1500 \text{ Ohms}$ —Your (average) body resistance

Now let's compute it.

$$I = 120/1500$$

$$I = .080$$

$$I = 80 \text{ milliamperes}$$

So if you grabbed a 120-vac wire, 80 milliamperes of current would flow through your body. Now use table 3-1 to determine the effect of 80 milliamperes of electric shock. You can see that you may not be around long enough to grab any more wires. You grabbed 80

Table 3-1.—Electric Shock Effects

HUMAN REACTION (at 60Hz)	CURRENT (milliamperes)
PERCEPTION—A slight tingling sensation	1.1
CAN'T LET GO—Arm and hand muscles close involuntarily (120 lb. person)	10.0
CAN'T LET GO—(175-lb. person)	16.0
CAN'T BREATHE—Paralysis of the chest muscles	18.0
HEART FIBRILLATION—Rapid irregular contractions of the heart muscles—could be fatal.	65.0

milliamps of current! That's 15 milliamps beyond what could be fatal. It's also 70 milliamps beyond the *can't-let-go* threshold, and 62 milliamps beyond what is needed to cause you to stop breathing.

It's important to remember that the 1500 ohms is just an average value. Body resistance varies from person to person and may often be LESS than 1500 ohms. When your skin is moist, your body resistance could be as low as 300 ohms. Also, breaks in your skin at the point of contact reduce your skin resistance to nearly zero.

Skin resistance is only important when you're handling voltages of less than 240 volts. If you get shocked by more than 240 volts, the voltage arc will burn through your skin and leave deep third-degree burns where it enters your body.

Time of Current Flow

The longer you're being shocked, the more chance there is for your heart to begin fibrillation. Fibrillation is the shocking of your heart into a useless flutter. Most people who die from electric shock die from fibrillation. Fibrillation in a normal adult is unlikely if the current in milliamperes is less than $116/t$, where t is the shock duration in seconds. The longer you are shocked, the less current is needed to cause heart fibrillation. Here are some examples of shock current levels and durations that would cause fibrillation:

- 21 milliamperes for 30 seconds
- 44 milliamperes for 7 seconds

- 67 milliamperes for 3 seconds

AVOIDING ELECTRIC SHOCK

The three basic ways to prevent yourself from receiving an electric shock can be summed up in three words: *isolate*, *insulate*, and *ground*.

1. **Isolate:** Isolate yourself from the source of electric shock. Make sure you secure the power to equipment before you attempt to remove it. And, make sure all electrical equipment covers, doors, and enclosures are kept in place when you're not *actually* working on the equipment. If you must leave live circuitry exposed, rope off the area, post appropriate signs, and warn your fellow workers of the danger.

2. **Insulate:** Make sure the electrical tools and equipment you use are properly insulated. Use only insulated hand and portable electric power tools. Frequently check power and extension cords for deterioration, cracks, or breaks. Breaks in the insulation of power and extension cords cause many electrical mishaps.

3. **Ground:** Electric current always follows the path of least resistance. To prevent yourself from being the unintentional path to ground, make sure your equipment is well grounded. This will direct any stray electric current to ground, thereby protecting you from electric shock. A good ground could also protect your equipment from excessive voltage spikes or lightning. For further information on equipment grounding, see *Shipboard Bonding, Grounding, and Other Techniques for Electromagnetic Compatibility and Safety*, MIL-STD-1310 (NAVY).

RESCUING VICTIMS OF ELECTRIC SHOCK

The first thing to do when you see someone being shocked is to secure the power. **DO NOT** touch a victim who is in contact with a live circuit, or you'll be shocked too. If you cannot secure the power, use a dry insulating material like a rope, a belt (without the buckle), or a wooden cane to remove the victim (by pulling, pushing, or rolling) from the live circuit or wire. Then, immediately call for medical personnel.

If the victim is unconscious **AND** you are certified to administer cardiopulmonary resuscitation (CPR), begin to do so.

The effects of the electric shock can range from mild surprise to death. It depends on the amount of

current, voltage, and the duration of the electric shock. It's hard to know exactly how a victim of electric shock has been affected. More than likely, the victim will be very pale or bluish in color and unconscious.

MEASURING VOLTAGE ON ENERGIZED EQUIPMENT

As an ET, you'll work on energized equipment. You will be troubleshooting a piece of electrical or electronic equipment, and the technical manual will instruct you to measure voltages or to check signal waveforms while the equipment is energized. But, before you hook up the multimeter or oscilloscope, there are certain safety precautions and procedures you **MUST** follow. They're designed to protect you from electric shock. These precautions and procedures are divided into two basic categories: (1) voltage measurements below 300 volts, and (2) voltage measurements above 300 volts.

MEASURING VOLTAGE BELOW 300 VOLTS

Most of the voltage measurements that you will make will be below 300 volts. Almost all of the newer electronic systems use voltages that are less than 28 volts, except for the main input ac power. Here are some safety procedures you should follow when you need to measure voltages below 300 volts:

1. Notify and obtain permission from the commanding officer (afloat) or your supervisor (ashore) to work on energized equipment. Some commands require you to complete a checklist before doing this.

2. Study the schematic and wiring diagrams of the equipment on which you'll be working. Note the location of the points you will be measuring and, also, the location of any other high-voltage points you should be careful not to measure or touch.

3. Remove all metal watches, belt buckles, rings (even wedding bands), and any other items that have exposed metal. If you're wearing a security badge, put it in your pocket.

4. Make sure you're wearing electrical safety shoes, if they were issued, and that you're standing on insulating rubber matting. If you must insert your hand into the enclosure of the energized equipment, wear a

Table 3-2.—Rubber Gloves

Class	Maximum Safe Voltage
0	750 volts
I	3000 volts
II	4000 volts
III	5000 volts

pair of electrical safety rubber gloves rated for the appropriate voltage (see table 3-2).

5. Have a co-worker stand by; don't work alone. Make sure your co-worker knows where to secure the power in case of emergency.

Follow these four safety precautions **whenever** you take measurements on energized equipment:

1. Always use test probes with safety guards or barriers on the probe tips. This will prevent your hand from inadvertently touching the probe tip.

2. Always use insulated alligator clips.

3. Always keep your body clear of any metal parts of the equipment on which you're working.

4. Try and keep one hand in your pocket or behind your back when taking the measurement. This will prevent you from creating a ground path for electric current flow through your body from hand to hand.

Here is an excerpt from a mishap report that will show the importance of following the above precautions:

Member could not get alligator clip on test lead to stay on probe so he held clip to probe with right hand. Member violated safety precautions by continuing to hold clip and probe while energizing the test lead with 1200 volts. Soon thereafter, the member touched the ground lead and received serious shock. The member was treated for minor burns on the palm.

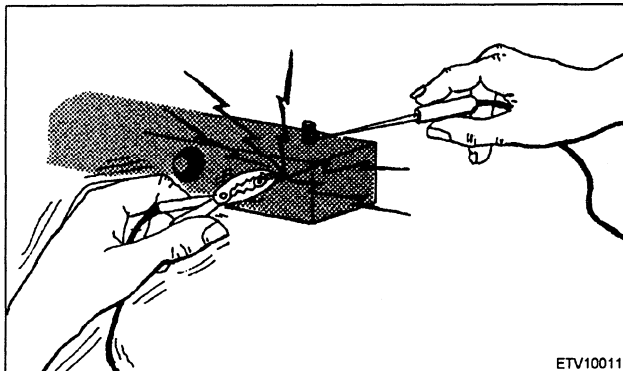

MEASURING VOLTAGE ABOVE 300 VOLTS

All the safety procedures for measuring voltages **below** 300 volts apply when you are measuring voltages **above** 300 volts. But, the big difference when measuring voltages above 300 volts is that you must **NOT** hold the test probe in your hand while the equipment is energized. Instead, you'll attach the test probes while the equipment is de-energized. Here are the safety procedures you should follow:

1. Follow all the preliminary safety procedures for measuring voltage **below** 300 volts before beginning your measurements.
2. Make sure the equipment you are working on is **DE-ENERGIZED**. Follow the required tag-out procedures.
3. With a shorting probe, discharge all high-voltage capacitors.
4. Attach the ground probe of the measuring device **first**.
5. Secure the other probe of the measuring device to the test point to be measured.
6. Make sure the measuring device is setup for the voltage level and polarity to be measured.
7. Energize the equipment under test, make the measurement, and then de-energize the equipment.
8. Discharge all high-voltage capacitors.
9. Remove the probes from the equipment.

ELECTROSTATIC DISCHARGE PRECAUTIONS

Electrostatic discharge (ESD) can destroy or damage many electronic components including integrated circuits (ICs) and discrete semiconductor devices. Certain devices are more susceptible to ESD damage than others. Because of this, warning symbols are now used to identify ESD-sensitive (ESDS) items (fig. 3-1).

Certified 2M technicians are trained in procedures for reducing the causes of ESD damage. The procedures are similar for all levels of maintenance. Some of the protective measures you should follow to prevent ESD damage are:

- Ground the work benches where ESDS devices will be handled.

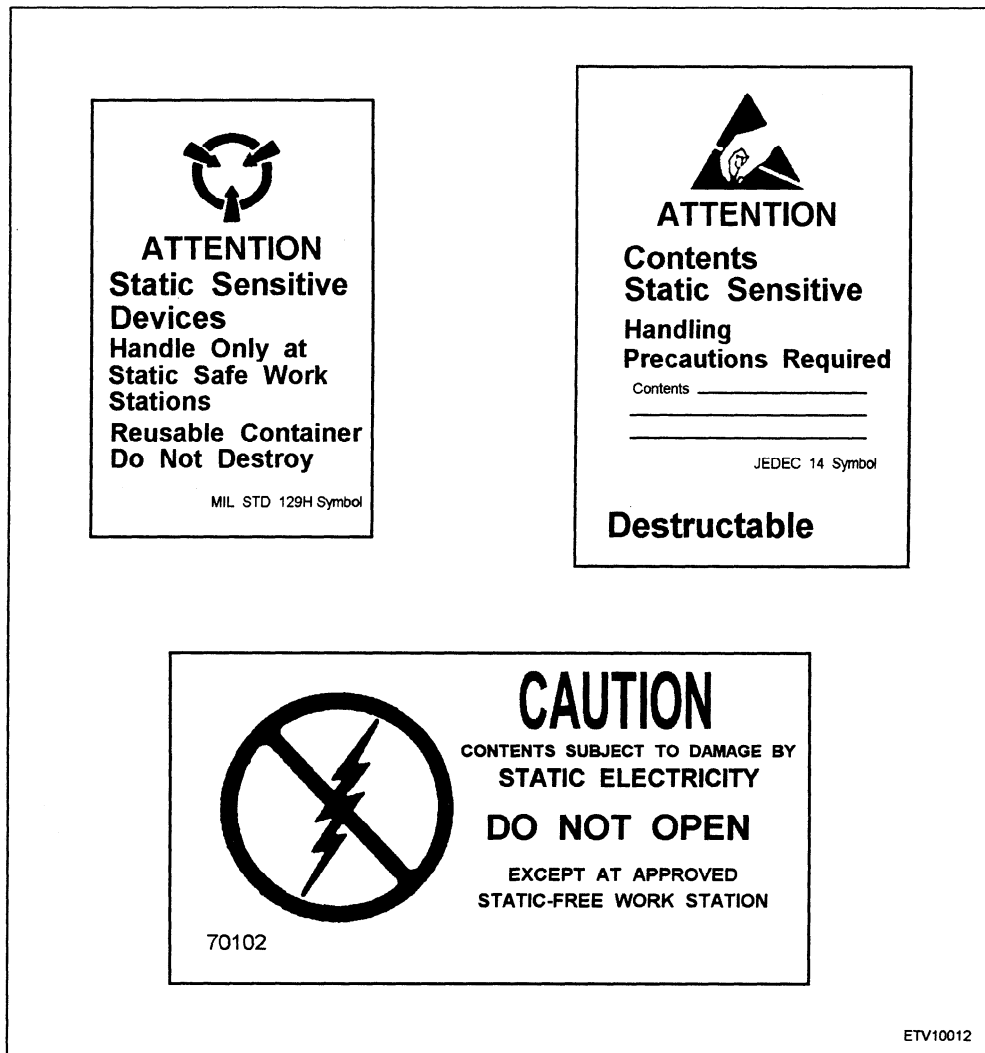

Figure 3-1.—Warning symbols for ESDS devices

- Be sure you are grounded.
 - Check packaging and equipment technical manuals for ESD warnings and instructions.
 - Before opening an electrostatic unit package of an ESDS device or assembly, ground the package.
 - Minimize the handling of ESDS devices or assemblies.
 - Avoid unnecessary physical movement.
 - When removing or replacing an ESDS device or assembly in the equipment, hold the device or assembly through the electrostatic free wrap if possible.
 - Do not permit ESDS devices or assemblies to come in contact with ungrounded materials.
 - When moving an ESDS device or assembly, always touch (with bare skin) the surface on which it rests for at least one second before picking it up.
 - When servicing ESDS devices, do not touch or handle materials that create static charges, or, be sure to repeat the grounding action.
 - When possible, avoid repairs that require soldering at the equipment level.
 - Ground the leads of test equipment before energizing test equipment and before probing ESDS items.
- Remember, although many sources of electrostatic charge are of little consequence during most daily activities, they become extremely important when you work with ESD material. For further information, refer

ELECTROMAGNETIC RADIATION HAZARDS

The electromagnetic spectrum encompasses everyday-use items from commercial power to medical x-rays, as shown in figure 3-2. In this area we will discuss radio frequency radiation and optical radiation.

R-F HAZARDS TO PERSONNEL

Radiation from antennas fed by high powered rf transmitters has the potential for injuring personnel who happen to be near the radiating antennas. Transmitters aboard ships, on aircraft, at shore stations, and microwave ovens found both aboard ships and ashore are potential sources of harmful radiation. At some frequencies, exposure to excessive levels of rf radiation will not produce a noticeable sensation of pain or discomfort to give warning that injury may be occurring. Radiated rf energy can also result in rf burns when metal objects with induced high rf voltage levels are touched.

An rf burn is the result of current flowing through the body when parts of the body are in contact with rf

voltages induced in conductive objects. The current produces heat as it passes through the resistance of the skin. The effect of the heat on a person ranges from warmth to painful burns.

LASER HAZARDS TO PERSONNEL

The word *laser* is an acronym for Light Amplification by Stimulated Emission of Radiation. A laser is basically a concentrated beam of optical radiation. As technology increases, the use of laser equipment will increase for purposes ranging from industrial to medical to military (both offensive and defensive).

The effects that lasers can have on your eyes range from inflammation of the cornea to corneal burn and on your skin from accelerated skin aging to skin burn.

If you are involved with the use of lasers at your command, be sure to follow all safety precautions for the class of laser in use and all directions given to you by your command's Laser Safety Officer. Lasers will be discussed in greater detail in volume 9 of this series.

We recommend that you become familiar with the contents of NAVSEA OP 3565/NAVAIR 16-1-529, Technical Manual, *Electromagnetic Radiation Hazards (U)*, (*Hazards to Personnel, Fuel, and Other Flammable Material*) (U). We also recommend that you

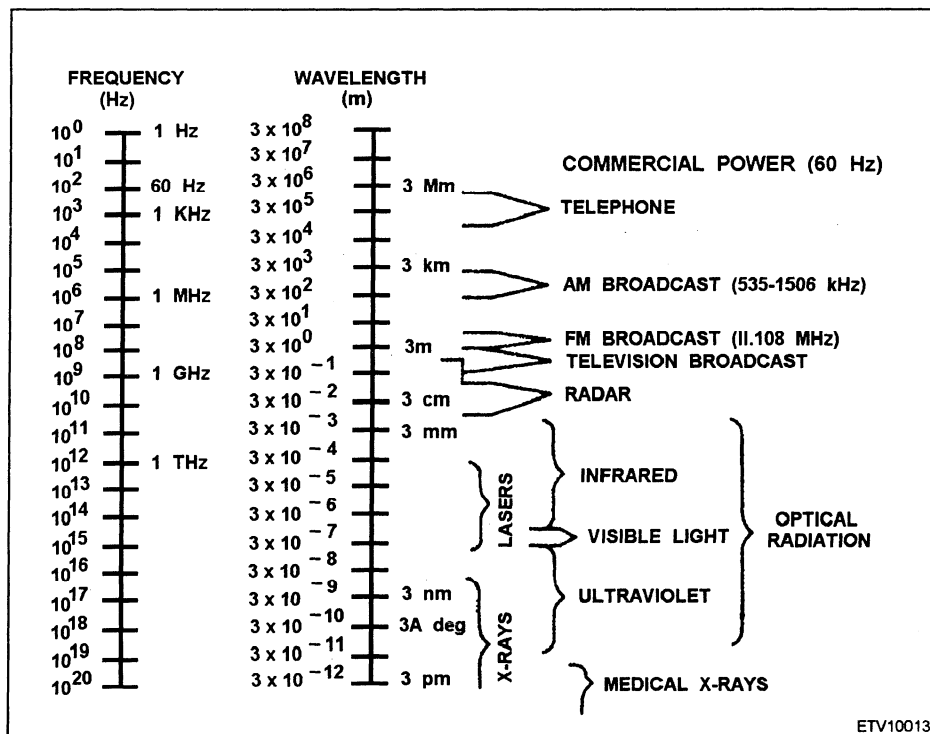

Figure 3-2.—Electromagnetic spectrum.

read chapter 22 of the *Navy Occupational Safety and Health (NAVOSH) Program Manual*, (OPNAVINST 5100.23) for shore operations, and chapter B9 of the *NAVOSH Program Manual for Forces Afloat* (OPNAVINST 5100.19).

TAG-OUT BILL

The tag-out bill is a system of documents used to save lives and to prevent unnecessary damage to equipment. It uses *CAUTION* tags and *DANGER* tags, *out-of-calibration* labels, and *out-of-commission* labels to let you know when a specific switch, circuit breaker, piece of equipment, electronic system, or plumbing valve should be either operated with extra care or completely left alone.

As an ET, you won't be securing many plumbing valves. But, you will be securing a **lot** of power switches and circuit breakers to do preventive and corrective maintenance on electronic systems and equipments. It's not possible in this topic to identify all situations requiring tag-out. However, here are a few situations that **do** require you to tag out the equipment:

Working Aloft or Over the Side: Since many areas on the exterior of a ship are inaccessible from decks or built-in work platforms, it becomes necessary to go aloft or over the side to reach these areas.

The greatest hazard associated with working aloft or over the side is the danger of a fall. Other hazards include the dropping of objects on (or by) personnel, radiation burns, and asphyxiation. When working aloft, the following must be observed:

- Do not go aloft on masts, maces, stacks, or king posts or be suspended over the side by a crane without first obtaining written permission from the O.O.D. in the form of a working aloft checklist.

- Wear supplied air respirators when working near stacks or exhaust which are actively discharging gases.

- Use a climber sleeve assembly in conjunction with the safety harness when going aloft where a climber safety rail is installed.

- Before commencement of work and every 15 minutes thereafter, pass a verbal warning over the 1 MC, **DO NOT ROTATE ANTENNAS, ENERGIZE OR RADIATE ANY ELECTRICAL OR ELECTRONIC EQUIPMENT WHILE PERSONNEL ARE WORKING ALOFT.** If personnel aloft are in the vicinity of the stacks add, **DO NOT BLOW TUBES OR**

LIFT SAFETY VALVES WHILE PERSONNEL ARE WORKING ALOFT.

- Inform ships in the vicinity that personnel will be working aloft to ensure they take appropriate action on operation of electrical or electronic equipment.

- Departments concerned shall ensure that all radio transmitters and radars that pose radiation hazards are placed in the STANDBY position and a sign placed on the equipment that reads:

SECURED PERSONNEL ALOFT
DATE _____ TIME _____ INITIALS _____

- Position a safety observer on deck near the work being performed. Outfit the safety observer with a safety harness, lanyards, and climber safety sleeve to permit rapid emergency assistance aloft if required. The safety observer shall keep the deck area beneath the work aloft free of unnecessary personnel.

Now, refer to *Navy Occupational Safety and Health (NAVOSH) Program Manual for Forces Afloat*, (OPNAVINST 5100.19), and read Chapter C8. Then return to this manual.

Corrective Maintenance: When you're working on equipment that must have its power secured, and there's a chance someone else could inadvertently reapply power while you are still working on it.

Preventive Maintenance: When planned maintenance system (PMS) maintenance requirement cards (MRCs) or equipment technical manuals direct you to secure electrical power.

Danger Exists: When you are operating an equipment that could endanger someone's life. This could apply to both mechanical and electrical faults.

TAG-OUT RESPONSIBILITIES

Commanding officers are responsible for the well-being of their people and the operational readiness of their equipments. They are ultimately responsible for making sure their personnel follow the appropriate tag-out procedures. To help do this, they assign *authorizing officers* who have authority to sign, issue, and clear tags and labels. There is usually one authorizing officer for each department. The authorizing officer can be a commissioned officer, chief petty officer, or petty officer. When the affected system will be rendered out-of-commission as a result of the tag out action, the Authorizing Officer shall obtain permission of the CO when appropriate and the cognizant Department Head

before effecting the tag-out. In addition, the Authorizing Officer shall notify the cognizant Division Officer of the requirement for the tag-out.

Your department's authorizing officer will:

- Make sure you are qualified to do the work you are about to do.
- Maintain the tag-out log(s).
- Sign and issue tag(s) and tag-out record sheet(s).
- Clear the record sheet(s) from the tag-out log(s) and destroy the tag(s) when the work is completed.

TAG-OUT DOCUMENTS

Tag-out documents consist of:

- A tag-out log
- CAUTION Tags (NAVSHIPS 9890/5) (yellow)
- DANGER Tags (NAVSHIPS 9890/8) (red)
- Out-of-Calibration Labels (NAVSEA 92 10/6)
- Out-of-Commission Labels (NAVSHIPS 9890/7)

We will discuss the first three items in depth. The last two items are labels used to identify test equipment that is either out of calibration or out of commission.

Tag-Out Log

A tag-out log is a permanent log of the authorizations given for all tag-out actions. It's kept in a

three-ring binder and has five sections that contain the following:

Section 1. A copy of the *Equipment Tag-Out Bill*, chapter 6, OPNAVINST 3120.32; and a copy of the command's *amplifying* instruction on equipment tag-out.

Section 2. DANGER/CAUTION Tag-Out Index and Record of Audits (OPNAV 3120/4). (See figure 3-3.) The authorizing officer uses this form to assign and track all of the issued DANGER/CAUTION tags.

Note that the blocks on figure 3-3 are labeled (A) through (E). Here is an explanation of each block:

- (A) LOG SERIAL: The sequential log serial number issued for tag-out actions.
- (B) DATE ISSUE: The date the log serial number was issued.
- (C) TYPE: The type of tags used, either DANGER or CAUTION.
- (D) DESCRIPTION: A description of the system or component that will be tagged-out and any amplifying information.
- (E) DATE CLEARED: The date that ALL the tags were cleared.

Section 3. DANGER/CAUTION Tag-out record sheets (NAVSEA 9210/9) that are still in effect. Figures 3-4 and 3-5 show the front and back sides of this form.

Note that the items on the form are labeled (A) through (R). When you tag out equipment, you must complete items (A) through (J) and item (M) on the form. Here's an item-by-item explanation of the form:

- (A) DATE/TIME TAG-OUT ISSUED: Enter the date and time the authorizing officer issued

DANGER/CAUTION TAG-OUT INDEX AND RECORD OF AUDITS				
LOG SERIAL	DATE ISSUE	TYPE (DANGER/CAUTION)	DESCRIPTION (SYSTEM, COMPONENT, WORK PERMIT OR TEST DOCUMENT REFERENCE)	DATE CLEARED
(A)	(B)	(C)	(D)	(E)

OPNAV 3120/4 (10-85)

ETV10014

Figure 3-3.—DANGER/CAUTION Tag-Out Index and Record of Audits (OPNAV 3120/4).

NAVSEA 9210/9 (REV. 3-86) (FRONT)
 DANGER/CAUTION TAG-OUT RECORD SHEET
 (CONT'D ON REVERSE)

DATE/TIME TAG-OUT ISSUED (A)

SYSTEM OR COMPONENT (B) LOG SERIAL NO. (C)

REASON FOR TAG-OUT (D)

PERSONNEL/EQUIPMENT HAZARDS INVOLVED (MANDATORY FOR DANGER TAGS) (E)

AMPLIFYING INSTRUCTION (MANDATORY FOR CAUTION TAGS) (F)

WORK NECESSARY TO CLEAR TAG(S) (INCLUDING TESTS) (G)

(H) OPERATIONS/WORK ITEMS INCLUDED IN TAG-OUT

APPLICABLE DOCUMENTATION (I.E. JOB ORDER, RIP OUT, SP, ETC.) NUMBER & TITLE	TAG NUMBERS USED	DATE/TIME ISSUED OR ADDED	PETTY OFFICER IN CHARGE	AUTHORIZING OFFICER	WORK COMPLETE		DATE
			SECOND PERSON (SIGNATURE)	REPAIR ACTIVITY REP. (WHEN APPROP.)	AUTH. OFFICER	REPAIR ACTIVITY REP. (WHEN APPROP.)	
(1)	(2)	(3)	(4)	(5)	(6)	(6)	

CHECK BOX OF CONTINUED ON ADD'L SHEET

ETV1A015

Figure 3-4.—DANGER/CAUTION Tag-Out Record Sheet NAVSEA 9210/9 (Front).

you a log serial number from the DANGER CAUTION Tag-Out Index and Record of Audit sheet.

- (B) SYSTEM OR COMPONENT: Enter the official nomenclature of the system or equipment you are tagging-out (example, AN/WSC-3[V]).
- (C) LOG SERIAL NO.: Enter the number assigned by the authorizing officer.

- (D) REASON FOR TAG-OUT: Briefly describe the reason for the tag-out (example, “Preventive maintenance”).
- (E) PERSONNEL/EQUIPMENT HAZARDS INVOLVED: Briefly describe any hazards that may exist (examples, “Shock hazard” or “Operation would damage equipment”).
- (F) AMPLIFYING INSTRUCTIONS: Briefly describe any other instructions that may apply.

officer and the repair activity representative, if applicable, certify the work completed and the tags cleared by signing and dating in the blocks provided.

- (I) TAG NO. (back side of form): List each tag separately. An example tag number is "76-3." The "76" is the issue log serial number. The "-3" indicates that the tag is the third one used.
- (J) LOCATION: Be specific. Give the power panel identification number and breaker identification number. If the tag-out action is on board a ship or submarine, also give the frame number. If the action is ashore, also give the building and room number.
- (K) TAGGED POSITION/CONDITION: State the position in which the tagged item should remain (examples; ON, OFF, OPEN, or CLOSED).
- (L) POSTED BY (INITIAL): The person who actually hangs the tag, initials here.
- (M) POSTING CHECKED BY: A second person, after checking to make sure the tag was attached correctly, initials here.
- (N) CLEARANCE/POSITION/CONDITION: State the position each tagged item should be in when the tag is cleared.

- (O) CLEARANCE AUTHORIZED: After you've completed the work, the authorizing officer and the outside repair activity authorize you, by signing here, to clear the tags.
- (P) DATE/TIME CLEARED: The person who removes the tag enters the date and time the tag is removed.
- (Q) CLEARED BY: The person who removes the tag initials here.
- (R) SIGNATURE OF WATCH OFFICER/DUTY OFFICER and DATE/TIME: The authorizing officer signs and dates the form here to certify that all switches, circuit breakers, etc., are returned to their normal operating position/condition.

Section 4: Instrument Log (NAVSHIPS 9890/10). This log is the record of all of the out-of-commission and out-of-calibration labels issued.

Section 5: DANGER/CAUTION Tag-out Record Sheets that have been cleared and are no longer in effect.

CAUTION Tags (NAVSHIPS 9890/5)

A CAUTION tag is a **yellow-colored** tag used only as a *precautionary measure* to give temporary **special** instructions, or to indicate that unusual caution must be exercised when operating the equipment to which the tag is attached (fig. 3-6).



Figure 3-6.—CAUTION Tag (yellow in color).

The instructions you write on the tag must state the specific reason the tag was attached. Do not use a CAUTION tag if there is a chance someone could be hurt or equipment could be damaged when operated using normal operating procedures. Use a DANGER tag instead.

DANGER Tag (NAVSHIPS 9890/8)

A DANGER tag is a **red** -colored tag used to prohibit operation of equipment that, if operated, could jeopardize the safety of personnel or damage equipment. Under **NO** circumstances may equipment be operated or removed when tagged with a DANGER tag (fig. 3-7).

TAG-OUT PROCEDURES

Before you tag out a piece of equipment, make sure you get your supervisor's permission. If the equipment is mission-critical, you may even need your division officer or department head's permission to tag out the equipment.

Now go to the *Standard Organization and Regulations of the U.S. Navy*, (OPNAVINST 3120.32), and read chapter 6, section 630.17.6, "Standard Tag-Out Procedures," and return to this manual.

PROTECTIVE EQUIPMENT

Wearing the correct protective equipment is essential to all persons in the Navy. It is especially important for the safety of electronics personnel. In the following paragraphs, we will discuss this equipment.

ELECTRICAL SAFETY SHOES

You may be issued a pair of electrical safety shoes when you report to your first duty station. You **should** wear them whenever you work on or around energized equipment for your own safety.

Take care of your electrical safety shoes. You can clean and shine them just like regular safety shoes. And when they become worn out or damaged, turn them into your supply petty officer for a new pair.

Electrical safety shoes do not have any exposed metal parts like you might find on regular safety shoes. They do have special non-conducting soles designed to protect you from electric shock. The soles are rated to insulate you from a maximum of 600 volts.

Electrical safety shoes are stocked in the Naval Supply System under the National Stock Number (NSN) 8430-00-611-XXXX. The "XXXX" part of the NSN specifies the shoe size.

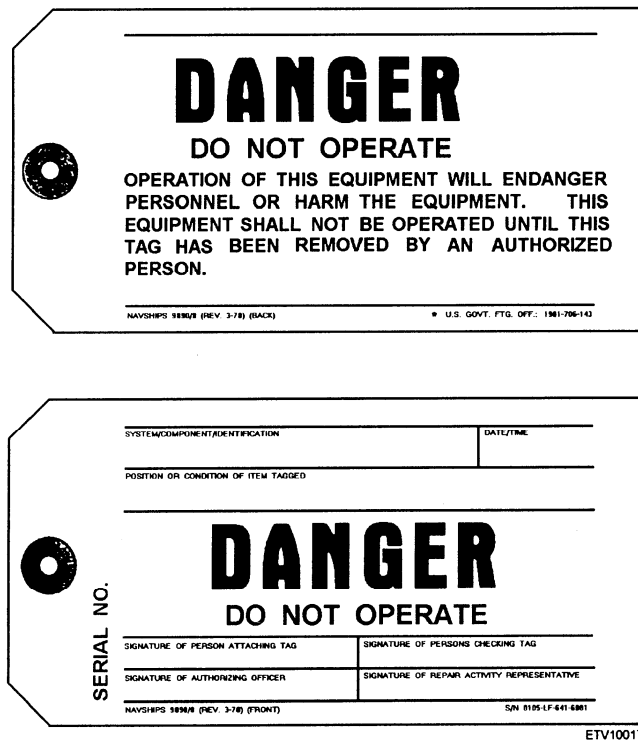

Figure 3-7.—DANGER Tag (red in color).

RUBBER GLOVES

There are four classes of rubber insulating gloves, the primary features being the wall thickness of the gloves and their maximum safe voltage rating. The classes and the maximum safe voltage for which the gloves can be used are listed in table 3-2.

Class 0 gloves are available in half-sizes from size 9 through size 12.

SAFETY SHORTING PROBE

Some of the electronic equipment you'll work on will use large capacitors to filter the electrical power. You **must** discharge these capacitors before you can begin any work on the equipment. To do this you will need to get a safety shorting probe and follow these procedures:

1. Make sure input power to the equipment has been secured. Use the appropriate tag-out procedures, if necessary.

2. Open the equipment to gain access to the capacitors that need to be discharged. **BE CAREFUL** not to touch any exposed terminals. Large filter capacitors can store a lot of energy. And if you touch the exposed terminals. . . **.ZAP!!**

3. Connect the flexible ground strap of the safety shorting probe to the metal chassis of the equipment. Make sure there is a good metal-to-metal connection.

4. While holding the safety shorting probe by its plastic handle, touch the metal probe tip to the appropriate terminals to be grounded. **BE CAREFUL** not to touch the metal probe tip or the flexible ground strap while the probe is in contact with the terminals of the capacitor. Repeat this step two or three times to ensure the capacitor is completely discharged.

Approved safety shorting probes are stocked by the Naval Stock System.

EYE PROTECTION

As an Electronics Technician, you depend heavily on your sense of sight in performing your job. To help protect your eyesight, you should know (1) when to wear eye protection, and (2) which eye protection to wear.

The *Navy Occupational Safety and Health (NAVOSH) Program Manual* (OPNAVINST 5100.23), states that you are **required to wear appropriate eye protective equipment when performing eye**

hazardous operations. In other words, whenever you're doing something that could damage your eyes, **WEAR EYE PROTECTION.** Some of the things you'll do that fall into this category are:

- Using an electric drill
- Soldering
- Maintaining batteries
- Cleaning and maintaining equipment using hazardous materials

Here are a few things to remember about eye protection:

- Eye protection isn't an option; it's a requirement. If you're doing something that calls for eye protection, take the time to get it and wear it. You can replace a scratched pair of goggles, but you can't replace a scratched eye.

- Wear eye protection even when you are just "walking around" hazardous activities.

- After you are through using eye protection equipment, clean it and store it properly.

HEARING PROTECTION

Hearing loss is a problem in the Navy. Every day, you'll be working with and around many noisy equipments and machinery that could damage your hearing. And, in most cases, the damage won't happen overnight; it will happen slowly. Your hearing will degrade until you will not be able to hear the softer sounds as well as you could have if you'd worn hearing protection. This is commonly called a *hearing threshold shift*. It simply means that **the more** you are exposed to damaging levels of noise, **the louder** normal sounds must be for you to hear them.

You must start NOW to protect yourself from hearing loss. OPNAVINST 5100.23 states that **"hearing protective devices shall be worn by all personnel when they must enter or work in an area where the operations generate noise levels of greater than 84 decibels."**

RESPIRATORY PROTECTION

Recall from chapter 2 the discussion of hazardous paints, solvents, and other materials associated with the cleaning and maintenance of electronic equipment and antennas. We cannot emphasize too strongly the importance of using the proper respiratory protection

when you use these materials. Be **sure** to ask your supervisor about the need for respiratory protection whenever you:

- Chip lead or chromate based paints while removing corrosion.
- Prime and paint the bases of antennas.
- Clean circuits with spray solvents and alcohol.

Whenever you perform these operations, be sure the work area has good ventilation. This will help prevent you from inhaling hazardous vapors and dusts.

DECK INSULATING MATERIAL

Your working environment should have deck insulating material (more commonly called *rubber matting*) to protect you and your shipmates from electric shock. It must be installed wherever work is done on energized electrical and electronic equipment. This includes electronic repair shops that have workbenches to work on electronic equipment.

The rubber matting should be rated for use in areas where the maximum voltage won't exceed 3000 volts. It

must be installed in one continuous run, at least 36" wide, and must extend at least 24" past each end of the workbench. If you must work on energized equipment located in an area where rubber matting is not installed, protect yourself from electrical shock by using a 6-foot piece of rubber matting as a portable safety deck. When you're done, roll it up and store it for the next job.

Rubber matting does a great job of protecting you from electric shock. But, it won't do it for long if you don't take care of it. Here are a couple of tips for keeping the insulating properties of rubber matting intact:

1. Always keep rubber matting clean and free of any excess dirt, oils, or oil-based products. When you clean rubber matting, **don't** use any abrasive cleaners or electric buffers. If you do, you will ruin its insulating effectiveness.

2. Periodically inspect the rubber matting for cuts, cracks, or excessive wear. If you notice any of these conditions, replace the entire piece of rubber matting.

Throughout this volume we have discussed safety issues that are important to Electronics Technicians. Now, you must take this knowledge and apply it to your everyday job. Remember, **SAFETY FIRST**.

APPENDIX I

REFERENCES USED TO DEVELOP THE TRAMAN

- Afloat Safety Program*, OPNAVINST 5100.21A, Chief of Naval Operations, Washington, DC, 1991.
- Cryptologic Technician Training Series, Module 14, *CTM Safety*, NAVEDTRA A95-14-44-89, Naval Education and Training Program Management Support Activity, Pensacola, FL, 1989.
- Electronics Installation and Maintenance Book, General*, NAVSEA SE000-00-EIM-100, Naval Sea Systems Command, Washington, DC, 1983.
- Electronics Installation and Maintenance Book, Radiac*, NAVSEA 097-LP-000-0050, Naval Sea Systems Command, Washington, DC, 1971.
- Military Standard Marking for Shipment and Storage*, MIL-STD-129L, U.S. Army Material Command Packaging, Storage, and Containerization Center, Tobyhanna, PA, 1990.
- Navy Occupational Safety and Health (NAVOSH) Program Manual*, OPNAVINST 5100.23B, Chief of Naval Operations, Washington, DC, 1991.
- Navy Occupational Safety and Health (NAVOSH) Program Manual for Forces Afloat*, OPNAVINST 5100.19B, Chief of Naval Operations, Washington, DC, 1989.
- Naval Ships' Technical Manual, Chapter 300, Electric Plant General*, NAVSEA S9086-KC-STM-000/CH-300, Naval Sea Systems Command, Washington, DC, 1989.
- Naval Ships' Technical Manual, Chapter 400, Electronics*, NAVSEA S9086-ND-STM-000/CH-400, Naval Sea Systems Command, Washington, DC, 1981.
- Naval Ships' Technical Manual, Chapter 670, Stowage, Handling, and Disposal of Hazardous General Use Consumables*, NAVSEA S9086-WK-STM-010/CH-670, Naval Sea Systems Command, Washington, DC, 1987.
- Protection of DOD Personnel from Exposure to Radio Frequency Radiation*, DODINST 6055.11, Department of Defense, Washington, DC, 1986.
- Radiation Health Protection Manual*, NAVMED P-5055, Bureau of Medicine and Surgery, Washington, DC, 1990.
- Shipboard Management Guide for Polychlorinated Biphenyls (PCBs)*, NAVSEA S9593-A1-MAN-010, Naval Sea Systems Command, Washington, DC, 1986.
- Standard Organization and Regulations Manual (SORM) of the U.S. Navy*, OPNAVINST 3120.32B, Chief of Naval Operations, Washington, DC, 1986.
- Technical Manual for Batteries, Navy Lithium Safety Program Responsibilities and Procedures*, NAVSEA S9310-AQ-SAF-010, Naval Sea Systems Command, Washington, DC, 1988.
- Technical Manual, Electromagnetic Radiation Hazards (U) (Hazards to Personnel, Fuel, and other Flammable Materials) (U), Volume I*, NAVSEA OP-3565, Naval Sea Systems Command, Washington, DC, 1989.
- Technical Manual, Electromagnetic Radiation Hazards (U) (Hazards to Ordnance) (U), Volume II*, NAVSEA OP-3565, Naval Sea Systems Command, Washington, DC, 1989.
- Technical Manual, LASER Safety, SPAWAR E0410-BA-GYD-010\7034 LASER*, Space and Naval Warfare Systems Command, Washington, DC, 1988.

INDEX

E

- Electric shock, 3-1
 - avoiding, 3-3
 - definition, 3-1
 - rescuing victims, 3-3
 - severity, 3-1
- Electromagnetic radiation hazards, 3-6
 - laser hazards to personnel, 3-6
 - rf hazards to personnel, 3-6
- Electrostatic discharge precautions, 3-4

H

- Hazardous materials, 2-1
 - information, 2-1
 - recognizing, 2-1
 - safety precautions, 2-3
 - stowage requirements, 2-9
 - types, 2-1

M

- Measuring voltage on energized equipments, 3-3
 - voltage above 300 volts, 3-4
 - voltage below 300 volts, 3-3
- Mishap causes, 1-3
 - behavioral factors, 1-6
 - communications problems, 1-8
 - equipment design factors, 1-8
 - inadequate or outdated procedures, 1-6
 - inadequate safety precautions, 1-6
 - inadequate training and experience, 1-4
 - medical factors, 1-7
- Mishap prevention, 1-8

P

- Protective equipments, 3-12
 - deck insulating material, 3-12
 - electrical safety shoes, 3-13
 - eye protection, 3-13
 - hearing protection, 3-13
 - rubber gloves, 3-13
 - safety shorting probe, 3-13

S

- Safety responsibilities, 1-9
 - command safety officer, 1-9
 - commanding officer, 1-9
 - department safety officer, 1-10
 - division safety officer, 1-10
 - division safety petty officer, 1-10
 - personal safety, 1-11

T

- Tag-out bill, 3-7
 - caution tag, 3-11
 - danger tag, 3-12
 - tag-out documents, 3-8
 - tag-out procedures, 3-12
 - tag-out responsibilities, 3-7
- Types of hazardous materials, 2-1
 - aerosol containers, 2-4
 - batteries, 2-5
 - cathode-ray tubes, 2-8
 - polychlorinated biphenyls (PCBs), 2-5
 - solvents, 2-4
 - vacuum tubes, 2-7

Assignment Questions

Information: The text pages that you are to study are provided at the beginning of the assignment questions.

ASSIGNMENT 1

Textbook Assignment: "Naval Safety," chapter 1, pages 1-1 through 1-9; "Hazardous Materials," chapter 2, pages 2-1 through 2-9; and "Electronic Safety," chapter 3, pages 3-1 through 3-13.

- 1-1. Which of the following occurrences is/are basic to a mishap?
1. A planned or intentional event
 2. Contact that causes injury or property damage
 3. Stops or interrupts work
 4. Both 2 and 3 above
- 1-2. In what year were safety engineers assigned to each major shipyard?
1. 1917
 2. 1929
 3. 1947
 4. 1951
- 1-3. What is/are the number one cause of mishaps?
1. Equipment
 2. Weather
 3. Personnel
 4. Broken tools
- 1-4. Who is the designated occupational safety and health (OSH) official for the Department of the Navy?
1. Chief of Naval Operations
 2. Vice Chief of Naval Operations
 3. Secretary of the Navy
 4. Assistant Secretary of the Navy
- 1-5. Who monitors safety and occupational health statistics and provides direct support and assistance to fleet units in safety matters?
1. Chief, Bureau of Medicine and Surgery
 2. Chief, Naval Education and Training
 3. Commander, Naval Sea Systems Command
 4. Commander, Naval Safety Center
- 1-6. Which of the following OPNAV instructions covers the Navy Occupational Safety and Health program?
1. 5100.12
 2. 5100.19
 3. 5100.21
 4. 5100.23
- 1-7. Of the following factors, which forms the basis of mishap prevention?
1. Mishaps are caused
 2. Tools are unsafe
 3. Training is inadequate
 4. Equipment is designed improperly
- 1-8. MAA/Safety Force personnel are roving inspectors for hazards that could result in injury to personnel or damage to equipment.
1. True
 2. False
- 1-9. Hazards that may cause severe injury, severe occupational illness, or major property damage are assigned what category?
1. I
 2. II
 3. III
 4. IV
- 1-10. If you are assigned a task that is beyond your skill level, you should take which of the following actions?
1. Skim over the technical documents before starting
 2. Take shortcuts to finish the task and look good to your supervisor
 3. Tell your supervisor and ask for assistance
 4. Refuse to do the work
- 1-11. There is no need to review all precautions for a task you have preformed many times before.
1. True
 2. False
- 1-12. Behavior that leads to a mishap is usually caused by which of the following problems?
1. Undesirable attitudes
 2. Lack of knowledge
 3. Undesirable motivations
 4. Both 1 and 3 above

- 1-13. What type of motivation can cause "jury-rigged" equipment?
1. Motivation to gain approval
 2. Motivation to save time
 3. Motivation to maintain personal comfort
- 1-14. Which of the following are incentives for specific acts?
1. Attitudes
 2. Unique past experiences
 3. Motivations
- 1-15. Which of the following is NOT a symptom of fatigue?
1. Boredom
 2. Confusion
 3. Impatience
 4. Irritability
- 1-16. Which of the following statements pertains to a mishap probability assigned subcategory B?
1. It is likely to occur immediately
 2. It will probably occur in time
 3. It is unlikely to occur
- 1-17. Which of the following problems can cause a communication problem and lead to a mishap?
1. A breakdown in the passing of information
 2. Misunderstanding information
 3. Language weakness
 4. All of the above
- 1-18. What law assures safe and healthful working conditions for every worker in the United States?
1. The Navy Safety Program
 2. The Occupational Safety and Health Act
 3. The Congressional Act on Safe Working Conditions
 4. The Consolidated Labor Union Workers' Benefits
- 1-19. What is the objective of the Navy's mishap prevention program?
1. To investigate all mishaps
 2. To prevent mishaps from occurring
 3. To prevent mishaps from reoccurring
 4. Both 2 and 3
- 1-20. When you need to delay correcting an unsafe condition, which of the following actions should you take?
1. Take whatever temporary precaution you need to protect yourself
 2. Take whatever temporary precautions you need to protect yourself and your coworkers
 3. Send a memo to your supervisor
 4. Send a memo to your division officer
- 1-21. Commanding officers can delegate their responsibilities for safety of all personnel under their command to the executive officer.
1. True
 2. False
- 1-22. Factors that can contribute to worker caused mishaps include
1. lack of experience, outdated procedures
 2. negative motivation
 3. medical and communication problems
 4. all of the above
- 1-23. The quantity of hazardous material stored in the work space should be limited to what amount?
1. Enough for one work shift
 2. Enough for one week
 3. Enough for one month

A.	CARBON-ZINC DRY-CELL BATTERY
B.	LITHIUM CELL BATTERY
C.	MANGANESE-DIOXIDE ALKALINE-ZINC CELL BATTERY
D.	LEAD-ACID CELL BATTERY
E.	MERCURIC-OXIDE ZINC CELL BATTERY
F.	NICKEL-CADMIUM CELL BATTERY

Figure 1-A.—Types of batteries

IN ANSWERING QUESTIONS 1-24 THROUGH 1-29, REFER TO FIGURE 1-A. MATCH THE TYPE OF BATTERY IN FIGURE 1-A WITH ITS MOST CORRECT CHARACTERISTIC(S) AND HAZARD(S) IDENTIFIED IN THE QUESTION.

- 1-24. Used in most cordless, rechargeable equipment; should not be stored in an area where lead-acid batteries are stored.
1. A
 2. C
 3. D
 4. F
- 1-25. Commonly called mercury cells; small and powerful; should not be exposed to heat over 400 degrees F.
1. A
 2. B
 3. D
 4. E
- 1-26. Most widely used wet-cell battery; battery gases are extremely explosive; contains sulfuric acid.
1. B
 2. C
 3. D
 4. F
- 1-27. Has high energy; is long lasting; could release toxic gases or explode.
1. A
 2. B
 3. C
 4. D
- 1-28. Commonly called an alkaline battery; used in portable radios; safety precautions same as for carbon-zinc batteries.
1. B
 2. C
 3. E
 4. F
- 1-29. Most common battery in the Navy; could explode if put into a fire.
1. A
 2. D
 3. E
 4. F
- 1-30. What group is responsible for the proper stowage of hazardous material in an area under their cognizance on board ships?
1. The supply department
 2. Individual work center personnel
 3. Both 1 and 2 above
- 1-31. You should never remove a cathode-ray tube unless its high voltage anode has been charged.
1. True
 2. False
- 1-32. The form and appearance of PCBs can range from oily liquids to crystalline solids.
1. True
 2. False
- 1-33. All hazardous material and hazardous material containers do not have to be labeled.
1. True
 2. False
- 1-34. If you dispense a hazardous material into an unlabeled container, what must you do?
1. Place a large red "X" on the outside of the container
 2. Use all of the dispensed material within 1 hour and then dispose of the container
 3. Both 1 and 2 above
 4. Indicate on the new container the same label information shown on the original container
- 1-35. Which of the following items must manufacturers of hazardous materials provide for users?
1. Information sheets on all hazardous materials they produce
 2. A material safety data sheet (MSDS) to the user for each hazardous material
 3. Both 1 and 2 above
 4. Protective clothing
- 1-36. Where are the MSDSs for a work center located at shore stations?
1. At the main supply center
 2. Within the work center
 3. The Safety Officer's files
 4. At public works

- 1-37. What is the background color of the DOT hazardous material shipping symbols for non-flammable gas?
1. Red
 2. Orange
 3. Yellow
 4. Green
- 1-38. You have the authority to relabel properly labeled hazardous material.
1. True
 2. False
- 1-39. Which of the following actions should you take when using hazardous solvents?
1. Spray solvents on electrical windings only
 2. Apply cleaning solvents to heated elements only
 3. Ensure there is adequate ventilation
 4. Place all rags used with the solvents in an open container outside of the workspace
- 1-40. Which types of solvents are the safest?
1. Oil-based
 2. Petrolatum-based
 3. Ammonia-based
 4. Water-based
- 1-41. What should you do before using an aerosol container?
1. Clear the area of all personnel
 2. Read the label
 3. Point the can away from you and test it
 4. Remove the label
- 1-42. Which of the following information is contained on an MSDS?
1. Ingredients and identity information
 2. Transportation data
 3. An emergency phone number
 4. All of the above
- 1-43. All equipment and cabinets containing in-service PCB capacitors must be marked with a label similar to the one shown in figure 2-3 of the text.
1. True
 2. False
- 1-44. Which of the following is a label used by the Navy on hazardous material?
1. Department of Defense Hazardous Chemical Warning Label
 2. Supply Corps Identification Label
 3. Department of the Navy Identification Label
 4. Supply Department Hazardous Warning Label
- 1-45. In which section of the Tag-Out Log will you find DANGER/CAUTION tag-out record sheets that have been cleared and are no longer in effect?
1. 2
 2. 3
 3. 4
 4. 5
- 1-46. The instrument log is found in which section of the Tag-Out Log?
1. 1
 2. 2
 3. 3
 4. 4
- 1-47. DANGER/CAUTION tag-out record sheets that are still in effect are kept in which section of the Tag-Out Log?
1. 1
 2. 2
 3. 3
 4. 5
- 1-48. Which of the following is the greatest hazard associated with working aloft?
1. The danger of a fall
 2. The dropping of objects
 3. Radiation burns
 4. Asphyxiation
- 1-49. An RF burn is the result of RF voltages passing through the body.
1. True
 2. False
- 1-50. Which of the following is the best basic description of a laser beam?
1. A concentrated beam of infrared light
 2. A concentrated beam of medical X-rays
 3. A concentrated beam of optical radiation
 4. A concentrated beam of electricity

- 1-51. When removing or replacing an ESDS device, which of the following actions should you take?
1. Ensure that you are grounded
 2. Move around, so you don't build up a static charge
 3. Hold the device through electrostatic-free wrap if possible
 4. Both 1 and 3 above
- 1-52. When measuring voltage above 300 volts, you should attach the test probe while the equipment is de-energized.
1. True
 2. False
- 1-53. What is the first action that you should take if you see someone being shocked?
1. Call for medical personnel
 2. Secure the area
 3. Remove the victim from the live circuit
 4. Secure the power
- 1-54. Information on equipment grounding can be found in which of the following publications?
1. NAVEDTRA 12052
 2. SECNAVINST 5216.5C
 3. MIL-STD-1310
 4. SPCCINST 4441.170
- 1-55. How much time, in seconds, is required for 44 milliamperes to cause your heart to begin fibrillation?
1. 3
 2. 7
 3. 14
 4. 30
- IN ANSWERING QUESTION 1-56, REFER TO TABLE 3-1 OF THE TEXT.
- 1-56. What is the "can't let go" current in milliamperes for a person weighing 175 pounds?
1. 10.0
 2. 16.0
 3. 18.0
 4. 65.0
- 1-57. Voltages over 240 volts will burn through the skin and leave deep third-degree burns where the charge enters the body.
1. True
 2. False
- 1-58. What is the resistance, in ohms, between major extremities of an average human body?
1. 500
 2. 1000
 3. 1500
 4. 2000
- 1-59. Of the following, which is the most dangerous path current can take through the body?
1. Hand to hand
 2. Left hand to either foot
 3. Right hand to either foot
 4. Foot to foot
- 1-60. Which of the following factors cause(s) electric shock?
1. Current
 2. Voltage
 3. Low body resistance
 4. Both 2 and 3 above
- 1-61. When personnel work aloft, a verbal warning must be passed over the IMC prior to commencement of the work and at what time intervals, in minutes, until the work is completed?
1. 5
 2. 10
 3. 15
 4. 20
- 1-62. Whose permission is required to work aloft?
1. Officer of the Deck
 2. Commanding officer
 3. Operations officer
 4. Engineer officer

1-63. Only qualified ship's force personnel may perform the second check of tag installation.

1. True
2. False

1-64. The number "70" in tag number 70-16 represents which of the following information?

1. The last two digits of the Julian date
2. The log serial number
3. The tag number

1-65. When tag requirements have been identified and the affected system will be rendered out-of-commission as a result of the tag-out, the authorizing officer must obtain permission from which of the following individuals prior to effecting the tag-out?

1. Commanding officer
2. Operations officer
3. Cognizant Department head
4. Both 1 and 3 above